

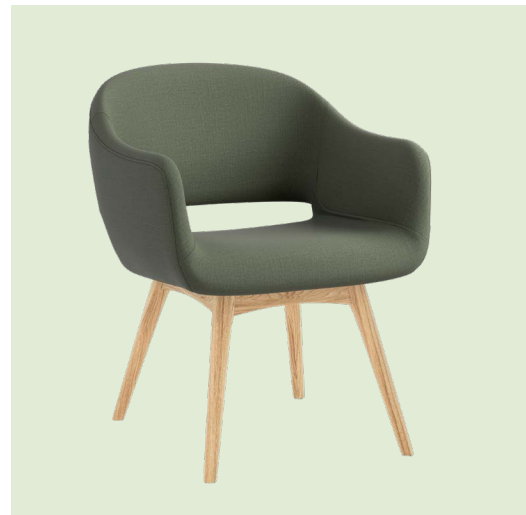

2025

OFFICE **FURNITURE** CATALOG



Konfurb Seating

With style up front and quality at its core, the Konfurb range turns everyday spaces into design statements. Drawing on the best of international design, this collection doesn't just look good—it's built to last. Perfect for commercial fit-outs, Konfurb combines striking aesthetics with exceptional craftsmanship. Customizable and versatile, it's designed to fit your vision, blending beauty, comfort, and durability seamlessly. From boardrooms to breakout areas, Konfurb is where style meets performance.

Clockwise from left: Neza (page 103), Neo (page 98), Crescent (page 101), Saron (page 97), Loop Series (page 120)

table of contents

04-28 : Classic Laminate
30-37 : Elements Laminate Collection
38-39 : Encore Collection
40-45 : Signature Collection
48-49 : Riser Series
50-53 : Height Adjustable
140-143 : Accessories

02

desking

56-59 : Webb Panels
60-61 : Borders
62 : SpaceMax Panels
63 : Drawing Services

54

panels

66-67 : Gathering Tables
68-71 : Training Room Tables
73-78 : Conference Tables
79-83 : Occasional Tables

64

tables &
presentations

86-89 : Chair Guide
90-98 : Reception & Lounge
99-113 : Management & Conference
114-121 : Task
122-123 : Big & Tall
124-125 : Drafting
126-139 : Guest & Multi-Purpose

84

seating

desking

RICH IN STYLING AND SUPERIOR IN CONSTRUCTION

The Performance Laminate Series offers an intelligent solution to any workstation need. Available in a wide range of components and sizes, it can be easily pieced together to create the configuration that best suits your needs. Attention to detail in design, quality of hardware, and use of premium grade laminate work surfaces ensure years of trouble free use.



Workstation Shown: PL177L/R, PL193, PL143, PL166(1), PL112, PL152, PL152SGD, PL144OH, PL44SGD, GBM1769WHITE List \$5039



SILVER BIRCH

CLASSIC LAMINATE SERIES



Workstation Shown: PL189, PL193, PL182L/R, PL166(1), PL144OH, PL44SGD, PLEDTL24, PL118FOSS, 33DBLUAUCCG-BLK List \$3285

FEATURES

- PVC Tough Edge on all exposed edges
- Top quality Steel Ball Bearing Drawer Slides
- Metal connections for increased durability
- Square drawer pulls for a premium look
- Core removable locks, grommets and leveling glides included
- Soft close hinges and soft close pedestal drawers



SLB Swatch



Includes Silver Square Handles

Edge Details



PVC Tough Edge

Hutch Options



See Pages 20-21

Tackboard Options



See Page 20

Handle Options



See Page 19



SILVER BIRCH CLASSIC LAMINATE SERIES



Workstation Shown: PL182L/R, PL192, PL166, PL207, PL144OH, PL44LD, GBM1769WHITE List \$3488

**FOR MATCHING
STORAGE +
ACCESSORIES**
see pages 19-21

Workstation Shown:
PL182L/R, PL192, PL166,
PL144OH, PL44SGD
List \$2078



Workstation Shown: PL189,
PL170, PL143, PL166(1),
PL144OH, PL44LD(2)
List \$2444



Workstation Shown:
PL133L/R, PL193, PL143, PL114
List \$2361



Workstation Shown:
PL101, PL145, PL166
List \$1326



Workstation Shown:
PL103, PL107
List \$790

ASPEN

CLASSIC LAMINATE SERIES



Workstation Shown: PL177L/R, PL193, PL143, PL166(1), PL112, PL152, PL152SGD, PL144OH, PL44SGD(2), PL118GREY List \$ 5138

FEATURES

- PVC Tough Edge on all exposed edges
- Top quality Steel Ball Bearing Drawer Slides
- Metal connections for increased durability
- Scalloped drawer pulls for a premium look
- Core removable locks, grommets and leveling glides included
- Soft close hinges and soft close pedestal drawers

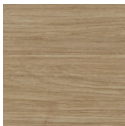

APN Swatch



Includes Black Scalloped Pulls

Edge Details



PVC Tough Edge

Hutch Options



See Pages 20-21

Tackboard Options



See Page 20

Handle Options



See Page 19



ASPEN

CLASSIC LAMINATE SERIES



FOR MATCHING STORAGE + ACCESSORIES
see pages 19-21

Workstation Shown: PL189, PL145, PL166(1), PL113, PL153, PL207 List \$3638



Workstation Shown:
PL133L/R, PL193, PL105, PL114,
PL144OH, PL44SGD, PL118GREY
List \$3325



Workstation Shown:
PL177L/R, PL193, PL143, PL166(1),
PL112, PL152, PL144OH, PL44LD,
PL118GREY, PL207 List \$5607



Workstation Shown:
PL103, PL107(2)
List \$1152



Workstation Shown:
PL105, PL196, PL107
List \$1176



Workstation Shown:
PL177L/R, PL179, PL166
List \$1585

CHERRY

CLASSIC LAMINATE SERIES



Workstation Shown: PL133L/R, PL193, PL143, PL114, PL144OH, PL44SGD, PL118GREY, PL207 List \$4656

FEATURES

- PVC Tough Edge on all exposed edges
- Top quality Steel Ball Bearing Drawer Slides
- Metal connections for increased durability
- Scalloped drawer pulls for a premium look
- Core removable locks, grommets and leveling glides included
- Soft close hinges and soft close pedestal drawers

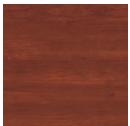

CHY Swatch



Includes Black Scalloped Pulls

Edge Details



PVC Tough Edge

Hutch Options



See Pages 20-21

Tackboard Options



See Page 20

Handle Options



See Page 19



CHERRY

CLASSIC LAMINATE SERIES



Workstation Shown: PL182L/R, PL192, PL166, PL144OH, PL445GD, PL118FOSS List \$2078

FOR MATCHING STORAGE + ACCESSORIES
see pages 19-21



Workstation Shown:
PL177L/R, PL196, PL166
List \$1655



Workstation Shown:
PL182L/R, PL192, PL107
List \$1184



Workstation Shown:
PL101, PL170, PL143, PL166(1)
List \$1726



Workstation Shown:
PL177L/R, PL193, PL143,
PL166(1) List \$2014



Workstation Shown:
PL121, PL107 List \$775

ESPRESSO

CLASSIC LAMINATE SERIES



Workstation Shown: PL178L/R, PL179, PL166 List \$1585

FEATURES

- PVC Tough Edge on all exposed edges
- Top quality Steel Ball Bearing Drawer Slides
- Metal connections for increased durability
- Scalloped drawer pulls for a premium look
- Core removable locks, grommets and leveling glides included
- Soft close hinges and soft close pedestal drawers



ESP Swatch



Includes Silver Scalloped Pulls

Edge Details



PVC Tough Edge

Hutch Options



See Pages 20-21

Tackboard Options



See Page 20

Handle Options



See Page 19



ESPRESSO

CLASSIC LAMINATE SERIES



FOR MATCHING STORAGE + ACCESSORIES
see pages 19-21

Workstation Shown: PL101, PL170, PL143, PL144OH, PL114, PL150, PL150/151SGD, PL118FOSS List \$4068

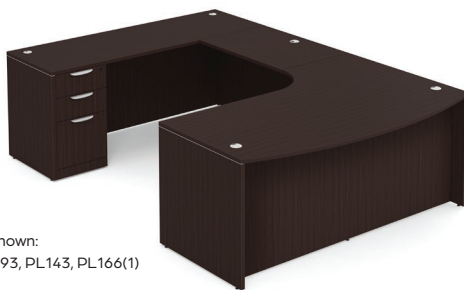

Workstation Shown:
PL177L/R, PL193, PL143, PL166(1)
List \$2014

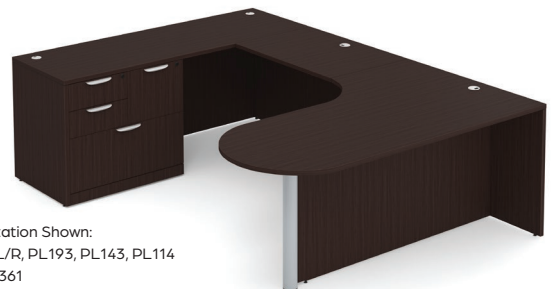

Workstation Shown:
PL133L/R, PL193, PL143, PL114
List \$2361



Workstation Shown:
PL182L/R, PL192, PL166
List \$1330



Workstation Shown:
PL133L/R, PL192, PL166
List \$1615



Workstation Shown:
PL103, PL166
List \$936

NEWPORT GRAY

CLASSIC LAMINATE SERIES



Workstation Shown: PL189, PL170, PL105, PL144OH, PL44LD, PL118FOSS, PL107(1) List \$2480

FEATURES

- PVC Tough Edge on all exposed edges
- Top quality Steel Ball Bearing Drawer Slides
- Metal connections for increased durability
- Scalloped drawer pulls for an enhanced look
- Core removable locks, grommets and leveling glides included
- Soft close hinges and soft close pedestal drawers



NPG Swatch



Includes Silver Scalloped Pulls

Edge Details



PVC Tough Edge

Hutch Options



See Pages 20-21

Tackboard Options



See Page 20

Handle Options



See Page 19



NEWPORT GRAY CLASSIC LAMINATE SERIES



**FOR MATCHING
STORAGE +
ACCESSORIES**
see pages 19-21

Workstation Shown: PL182L/R, PL192, PL166, PL207, PL144OH, PL44LD, GBM1769WHITE List \$3488



Workstation Shown: PL189, PL197,
PL143, PL166(1), PLPULL-R(3)
List \$1847



Workstation Shown:
PL177L/R, PL179, PL166
List \$1585



Workstation Shown:
PL102, PL166
List \$978



Workstation Shown:
PL133L/R, PL192, PL166
List \$1615



Workstation Shown:
PL182L/R, PL192,
PL166 List \$1330

NEWPORT GRAY

CLASSIC LAMINATE SERIES



Workplace Shown: PL101, PL194, PL175, PL144OH, PL44SGD, PL118GREY List \$2167



Workplace Shown: PL101, PL145, PL107(2) List \$1542



Workplace Shown: PL189, PL166, PL175 List \$1584



Workplace Shown: PL133L/R, PL193, PL143, PL114 List \$2361



NEWPORT GRAY CLASSIC LAMINATE SERIES



Workplace Shown: PL101, PL194, PL175, PL144OH, PL44LD, GBM1769, PLPULL-RBK(2) List \$2161

Workplace Shown: PL189, PL193,
PL143, PL166(1), PL144OH,
PL44LD(2) List \$2399



Workplace Shown: PL189, PL197, PL143, PL166(1), PL144OH, PL44SGD(2), PL118VISC List \$2933

MODERN WALNUT

CLASSIC LAMINATE SERIES



Workstation Shown: PL177L/R, PL179, PL107(1) List \$1439

FEATURES

- PVC Tough Edge on all exposed edges
- Top quality Steel Ball Bearing Drawer Slides
- Metal connections for increased durability
- Scalloped drawer pulls for an enhanced look
- Core removable locks, grommets and leveling glides included
- Soft close hinges and soft close pedestal drawers

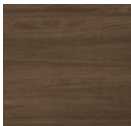

MWN Swatch



Includes Silver Scalloped Pulls

Edge Details



PVC Tough Edge

Hutch Options



See Pages 20-21

Tackboard Options



See Page 20

Handle Options



See Page 19



MODERN WALNUT

CLASSIC LAMINATE SERIES

FOR MATCHING STORAGE + ACCESSORIES
see pages 19-21



Workstation Shown: PL143, PL207, PL114, PL144OH, PL44SGD, GBM1769WHITE List \$3596



Workstation Shown:
PL189, PL197, PL143, PL166 (1),
PL144OH, PL44LD (2), PL118GREY
List \$2608



Workstation Shown:
PL133L/R, PL193, PL143, PL114
List \$2361



Workstation Shown:
PL103, PL166
List \$936



Workstation Shown:
PL177L/R, PL196, PL107
List \$1509



Workstation Shown:
PL182L/R, PL192, PL166
List \$1330

MAPLE

CLASSIC LAMINATE SERIES



Workplace Shown: PL101, PL145, PL166, PL175, PL144OH, PL44SLIDESGD(2), PL44RAIL, PL118VISC List \$3089



Workstation Shown:
PL133L/R, PL192,
PL166 List \$1615



Workstation Shown:
PL102, PL166
List \$978

**FOR MATCHING
STORAGE +
ACCESSORIES**
see pages 19-21

FEATURES

- PVC Tough Edge on all exposed edges
- Top quality Steel Ball Bearing Drawer Slides
- Metal connections for increased durability
- Scalloped drawer pulls for an enhanced look
- Core removable locks, grommets and leveling glides included
- Soft close hinges and soft close pedestal drawers



MPL Swatch



Includes Black Scalloped Pulls

Edge Details



PVC Tough Edge

Hutch Options



See Pages 20-21

Tackboard Options



See Page 20

Handle Options



See Page 19



STORAGE SOLUTIONS

CLASSIC LAMINATE SERIES

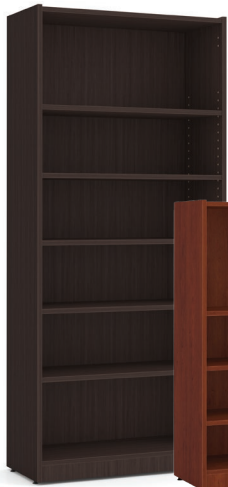

71" High Bookcase
 Model No. PL156
 4 Adjustable Shelves
 1 Fixed Shelf
 32"W x 14"D x 71"H
 List \$504



48" High Bookcase
 Model No. PL155
 3 Adjustable Shelves
 32"W x 14"D x 48"H
 List \$362

30" High Bookcase
 Model No. PL154
 1 Adjustable Shelf
 32"W x 14"D x 30"H
 List \$248



PL156, PLBCDK
 4 Adjustable Shelves
 1 Fixed Shelf
 List \$663



PL150, PL150/151SGD
 4 Adjustable Shelves
 List \$1095



PL207
 2 Adjustable Shelves
 List \$1287



PL151
 4 Adjustable Shelves
 List \$1015



PL112, PL152, PL152SGD
 2 Adjustable Shelves
 List \$2002



PL153, PL112
 2 Adjustable Shelves
 List \$1216



PL184
 List \$2190



PL183
 List \$1933



PL152
 2 Adjustable Shelves
 List \$709



PL114
 List \$834



PL112
 List \$834



PL113
 1 Adjustable Shelf
 List \$576

Available Finishes



*Maple and White – please call for availability.



PLPULL-RSI
 List \$19



PLPULL-RBK
 List \$19



PLPULL-HLLBK
 List \$16



PLPULL-HLLBSI
 List \$16

For detailed product information and options, please contact your sales representative.



HUTCH OPTIONS

CLASSIC LAMINATE SERIES



Open Hutch
 15"D x 36"H
 PL144OH - 71"W List \$541
 PL140OH - 66"W List \$521
 PL141OH - 60"W List \$510
 Shown with optional magnetic glass board



Hutch With 2 Silver Frame Glass Doors
 15"D x 36"H
 PL144OH/PL44SGD - 71"W List \$748
 PL140OH/PL40SGD - 66"W List \$728
 PL141OH/PL41SGD - 60"W List \$717



Hutch With 2 Laminite Doors
 15"D x 36"H
 PL144OH/PL44LD - 71"W List \$596
 PL140OH/PL40LD - 66"W List \$576
 PL141OH/PL41LD - 60"W List \$565
 Shown with optional Fossil tackboard



Hutch With 4 Silver Frame Glass Doors
 15"D x 36"H
 PL144OH/PL44SGD(2) - 71"W List \$955
 PL140OH/PL40SGD(2) - 66"W List \$935
 PL141OH/PL41SGD(2) - 60"W List \$924
 Shown with optional Fossil tackboard



Hutch With 4 Laminite Doors
 15"D x 36"H
 PL144OH/PL44LD(2) - 71"W List \$651
 PL140OH/PL40LD(2) - 66"W List \$631
 PL141OH/PL41LD(2) - 60"W List \$620
 Shown with optional Charcoal tackboard



Hutch with 4 Silver Frame Sliding Glass Doors
 15"D x 36"H X 71"W
 PL144OH/44RAILSI/44SLIDESGD(2)
 List \$1067
 Shown with optional magnetic glass board

Tackboard Options

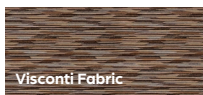
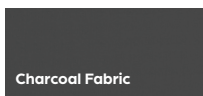

Tackboard - Charcoal Fabric
 PL115GREY 16.5"H X 58"W Fits PL141 List \$150
 PL116GREY 16.5"H X 45.5"W Fits PL125 List \$149
 PL117GREY 16.5"H X 64"W Fits PL140 List \$154
 PL118GREY 16.5"H X 69"W Fits PL144 List \$167

Tackboard - Visconti Fabric
 PL115VISC 16.5"H X 58"W Fits PL141 List \$165
 PL116VISC 16.5"H X 45.5"W Fits PL125 List \$163
 PL117VISC 16.5"H X 64"W Fits PL140 List \$170
 PL118VISC 16.5"H X 69"W Fits PL144 List \$188

Tackboard - Fossil Fabric
 PL115FOSS 16.5"H X 58"W Fits PL141 List \$165
 PL116FOSS 16.5"H X 45.5"W Fits PL125 List \$163
 PL117FOSS 16.5"H X 64"W Fits PL140 List \$170
 PL118FOSS 16.5"H X 69"W Fits PL144 List \$188

Available Finishes



*Maple and White - please call for availability.

WALL MOUNTED STORAGE

CLASSIC LAMINATE SERIES



A. Wall Mounted Storage without Doors
15"D x 17"H x 36.5"W
PL208OH List \$385



B. Wall Mounted Storage with 2 Silver Frame Sliding Glass Doors
15"D x 17"H x 36.5"W PL208OH, PL08RAILSI, PL44SLIDESGD
List \$664



C. Wall Mounted Storage with 2 Laminate Doors
15"D x 17"H x 36.5"W PL208OH/PL44LD List \$440



D. Wall Mounted Storage with 2 Silver Frame Glass Doors
15"D x 17"H x 36.5"W PL208OH/PL44SGD
List \$592



E. Wall Mounted Storage without Doors
15"D x 17"H x 71"W
PL20440H List \$641



F. Wall Mounted Storage with 2 Silver Frame Glass Doors
15"D x 17"H x 71"W
PL20440H/PL44SGD List \$848



G. Wall Mounted Storage with 2 Laminate Doors
15"D x 17"H x 71"W
PL20440H/PL44LD List \$696



H. Wall Mounted Storage with 4 Silver Frame Glass Doors
15"D x 17"H x 71"W
PL20440H/PL44SGD(2) List \$1055



I. Wall Mounted Storage with 4 Laminate Doors
15"D x 17"H x 71"W
PL20440H/PL44LD(2) List \$751



Wall Mounted Storage with 2 Silver Frame Sliding Glass Doors
15"D x 17"H x 71"W
PL20440H/PL44RAIL/PL44SLIDE
List \$958

LED Task Lights For Hutch



PLEDTL24 - 24"W List \$263



Wall Mounted Storage with 4 Silver Frame Sliding Glass Doors
15"D x 17"H x 71"W
PL20440H/PL44RAIL/PL44SLIDE(2)
List \$1167

Vertical Hutch Organizer



PL122 12"W x 18.5"H x 12.5"D
List: \$151



Glass Dry Erase Boards



GBM1769WHITE 17" x 69"
Fits inside a PL144 Hutch List \$275
(see page 69)

Hutch Doors with Lock



For PL144OH Hutch only
PL44LDLOCK List \$132



RECEPTION SOLUTIONS

CLASSIC LAMINATE SERIES



Workstation Shown: PL182L, PL182R, PL192(2), PL166(2), PBP12(6), PB21271ACRYL(4), PBTC71L(2), PBTC71R(2) List \$5410

FEATURES

- PVC Tough Edge on all exposed edges
- Top quality Steel Ball Bearing Drawer Slides
- Metal connections for increased durability
- Scalloped or Square drawer handles for an enhanced look (see page 19)
- Core removable locks, grommets and leveling glides included

Available Transaction Top Finishes



Available Finishes



*Maple – please call for availability.



Workstation Shown: PL182L, PL182R, PL192(2), PL166(2), PBP12(6), PB21271ACRYL(4), PBTC71L(2), PBTC71R(2) List \$5410

FOR BORDERS

see pages 61



Workstation Shown: PL182L/R(1), PL192(1), PL107(1), PBP12(3), PB21271ACR(2), PBTC71L(1), PBTC71R(1) List \$2559

RECEPTION SOLUTIONS

CLASSIC LAMINATE SERIES



Workstation Shown: PL169NTT(4), PL180(4), PL107(8) List \$7092



Workstation Shown: PL169NTT, PL180, PL166, PL175 List \$2065



Workstation show: PL169NTT, PL169DELTT, PL180, PL166 List \$2032



Front View of Deluxe Transaction Top (Available in White only)

Glass Transaction Top with Risers

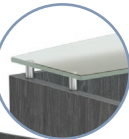

Workstation Shown: PL169NTT, PL169TTGLASS, PL180, PL166 List \$2044



Workstation Shown: PL169NTT, PL169TT, PL107 List \$1161

**CLASSIC LAMINATE SERIES
COMPONENT GUIDE**



Desk Shell	List
PL101 71"W x 36"D	\$501
PL105 71"W x 30"D	\$501
PL102 66"W x 30"D	\$470
PL103 60"W x 30"D	\$428
PL121 48"W x 30"D	\$413
PL104 48"W x 24"D	\$410



Bow Front Desk Shell	
PL189 – 71"W x 36/41D	\$568
PL187 – 66"W x 30/36D	\$563



Bow Front w/Corner Ext.	
PL177 L (shown) or R 71"W x 30"/36"/48"D	\$834



Desk Shell w/Corner Ext.	
PL178 L (shown) or R 71"W x 30" x 42"D	\$834



Bullet	
PL131 66"W x 30"D	\$473
Comes with MS720 Post	



Conference Bullet	
PL106 71"W x 36"/30"D	\$536
Comes with MS720 Post	



Bullet w/ Corner Ext.	
PL133L/MS725 (shown) or R 71"W x 30"/42"D	\$855



Credenza w/Corner Ext.	
PL182 L or R (shown)	\$570
71"W x 24/36"D	
PL181 L or R (shown)	\$541
66"W x 24/36"D	



Credenza Shell	List
PL143 71"W x 24"D	\$452
PL111 66"W x 24"D	\$437
PL129 60"W x 24"D	\$424
PL142 half leg	\$90



Reception Desk Shell	
Without transaction top	
PL169NTT 71"W x 30"D x 41"H	\$660

Transaction Top

Use with or without risers	
PL169TT 71"W	\$139

Glass Transaction Top with Risers

PL169TTGLASS 71"W	\$487
-------------------	-------

Transaction Top Riser

Brushed aluminum riser set	
PL169RISERBRU	\$84

Reception Return – Reversible

PL180 42"W x 24"D x 41"H	\$389
--------------------------	-------

Deluxe Transaction Top Organizer

PL169DELTT	\$475
------------	-------



Bridge	
PL170 48"W x 24"D	\$265
PL197 42"W x 24"D	\$262
PL193 35.5"W x 24"D	\$220
PL188 30"W x 24"D	\$212
PL195 24"W x 24"D	\$201



Return – Reversible	
PL145 48"W x 24"D	\$317
PL196 42"W x 24"D	\$313
PL192 35.5"W x 24"D	\$252
PL179 30"W x 24"D	\$243
PL194 24"W x 24"D	\$243



Corner Desk Shell	
PL134 42"W x 24"D	\$563



Hanging Pedestal – 3/4 (15.75"W)	
Unfinished Top	
PL107 Box / File 22"D	\$362

Deluxe Pedestal – Full (15.75"W)

Unfinished Top	
PL166 2 Box / File 22"D	\$508
PL175 File / File 22"D	\$508

Under Shelf Mount Open Filing

Unfinished Top	
PL1066 – 16"W x 22"D x 11.5"H	\$221



Pedestal Top	List
PL66T 22.5"D x 16"W	\$63
for PL166,175 or 1066	

Cabinet Top

PL110 71"W x 22"D	\$201
Common top used when combining a pair of PL112 or PL113 cabinets to create a single credenza.	

Mobile Pedestal 15.5"W x 22"D

PL148 2 Box/File 28.25"H	\$621
PL149 2 File 28.25"H	\$621
PL248* 2 Box/File 26.5"H	\$621
PL249* 2 File 26.5"H	\$621

*Updated size, now fits under Elements. Available Summer 2025

Mobile Pedestal 16"W x 22.5"H

PL1007 Box/File 22"D	\$452
CUSH1522 Cushion for PL1007	\$132

(See page 141 for cushion colors)



Open Hutch 15"D x 36"H	
PL141OH 60"W	\$510
PL140OH 66"W	\$521
PL144OH 71"W	\$541

Hinged Laminate Doors For Open Hutch

(Set of 2 doors)	
PL41LD for PL141OH	\$55
PL40LD for PL140OH	\$55
PL44LD for PL144OH	\$55

Locking Laminate Doors for Open Hutch

(Set of 2 doors)	
PL44LDLOCK for PL144OH	\$132

Hinged Aluminum Silver Frame Glass Doors For Open Hutch

(set of 2 doors)	
PL41SGD for PL141OH	\$207
PL40SGD for PL140OH	\$207
PL44SGD for PL144OH	\$207

Sliding Aluminum Silver Frame Glass Doors For Open Hutch

PL44SLIDESGD/PL44RAILSI	\$317
Set of 2 sliding doors for for PL144OH	
PL44SLIDESGD(2)/PL44RAILSI	\$526
Set of 4 sliding doors for for PL144OH	

Hutch with 2 Laminate Doors

PL125 48"W x 36"H x 15"D	\$56
--------------------------	------

Vertical Hutch Organizer (Black)

PL122 – 12"W x 18.5"H x 12.5"D	\$151
--------------------------------	-------

Tackboard – Charcoal Fabric

PL115GREY Fits PL141	\$150
PL116GREY Fits PL125	\$149
PL117GREY Fits PL140	\$154
PL118GREY Fits PL144	\$167

Tackboard – Visconti Fabric

PL115VISC Fits PL141	\$165
PL116VISC Fits PL125	\$163
PL117VISC Fits PL140	\$170
PL118VISC Fits PL144	\$188

Tackboard – Fossil Fabric

PL115FOSS Fits PL141	\$165
PL116FOSS Fits PL125	\$163
PL117FOSS Fits PL140	\$170
PL118FOSS Fits PL144	\$188



Open Wall Mounted Storage 17"H	List
PL208OH 36.5"W x 14.75"D	\$385
PL2044OH 71"W x 14.75"D	\$641

Hinged Laminate Doors for Open Wall Mounted Storage

(Set of 2 doors)	
PL44LD For PL208OH & PL2044OH	\$55

Locking Laminate Doors for Open Wall Mounted Storage

(set of 2 doors) PL44LDLOCK	
For PL208OH & PL2044OH	\$132

Hinged Aluminum Silver Frame Glass Doors for Open Wall Mounted Storage

PL44SGD For PL208OH & PL2044OH (Set of 2 doors)	\$207
---	-------

Sliding Aluminum Silver Frame Glass Doors for Open Wall Mounted Storage

PL44SLIDESGD/PL08RAILSI	\$279
Set of 2 sliding doors for PL208OH	
PL44SLIDESGD(2)/PL44RAILSI	\$526
Set of 4 sliding doors for PL2044OH	



Combo Lateral File w/ Removable Top	
PL114 Box/Box/File w/1 Lat.	\$834
31"W x 22"D x 29"H	



2-Drawer Lateral File 29"H With Removable Top	
PL112 36"W x 22"D	\$834

3-Drawer Lateral File 42"H

PL183 36"W x 22"D	\$1933
-------------------	--------

4-Drawer Lateral File 54.5"H

PL184 36"W x 22"D	\$2190
-------------------	--------



Storage Cabinets 29.5"H	
PL113 22"D x 36"W	\$576



Open Hutch 36"H	
PL153 36"W x 14"D	\$382
(Doors not available)	



Storage Cabinets 37.75"H	
PL152 22"D x 35.5"W	\$709



CLASSIC LAMINATE SERIES COMPONENT GUIDE



Storage Cabinets 65.5"H

- PL150 24"D x 18"W
- PL207 24"D x 24"W
- PL151 22"D x 36"W

- List \$833
- List \$1287
- List \$1015

Silver Frame Tempered Glass Doors

Pulls not included.

- PL152SGD Set of 2 for PL152 \$459
- PL113SGD Set of 2 for PL113 \$263
- PL150/151SGD Single door for PL150 \$262
- PL150/151SGD(2) Set of 2 for PL151 \$524



Bookcases 31.5"W x 14"D

- PL154 30"H 1 Adj. Shelf \$248
- PL155 48"H 3 Adj. Shelves \$362
- PL156 71"H 4 Adj. Shelves \$504

- List \$248
- List \$362
- List \$504

PLBCDK Laminate Door Kit 261/4"H for PL154, PL155 or PL156 mounts on bottom only (see page 19)

- List \$159

PL156SHELF

Extra shelf for PL154, 155 & 156

- List \$55

LED Task Light

PLEDTL24 24"

- List \$263

Scalloped Drawer Pulls – 128mm

- PLPULLHL128BLK Black Pull \$16
- PLPULLHL128SIL Silver Pull \$16

- List \$16
- List \$16

Square Drawer Pulls – 128mm

- PLPULLRSI Silver Pull \$19
- PLPULLRBK Black Pull \$19

- List \$19
- List \$19

Square Metal Grommet Cover 2.5"D

- PLSQGRMSI – Silver \$28
- PLSQGRMBK – Black \$28

- List \$28
- List \$28

Round Plastic Grommet Cover 2.5"D

- PLGROMMET – Black \$12
- PLGROMMET – Silver \$12

- List \$12
- List \$12

Lock Core Kit

PLLOCKCORE

Includes one core removable key, one new core, two keys. Must specify if keying alike is required.

- List \$27

Complete Lock Assembly

Includes complete lock assembly and two keys.

- PLLOCKSPEDESTAL \$45
- PLLOCKSCABINET \$45

- List \$45
- List \$45

Master Key

PLMKEY

- List \$36

Typical Configurations

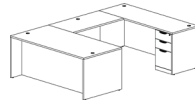

Rectangular U-Station

- PL101/170/143/166 71"W x 107"D List \$1726
- PL102/197/111/166 66"W x 96"D List \$1677

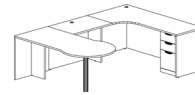

Conference Bullet U-Station with Back Inner Curve

- PL106/193/182L/166 71"W x 105"D List \$1834

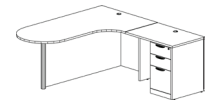

Bullet L Desk with Inner Curve

- PL133R/192/166 71"W x 77"D List \$1615



Bowfront U-Station

- PL189/170/143/166 71"W x 112"D List \$1793



Bullet U-Station

- PL131/170/111/166 66"W x 101"D List \$1683

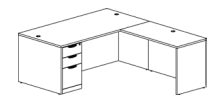

Rectangular L Desk

- PL101/145/166 71"W x 83"D List \$1326
- PL102/196/166 66"W x 72"D List \$1291



Bowfront U-Station with Front Inner Curve

- PL177R/193/143/166 71"W x 107"D List \$2014

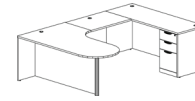

Bullet U-Station with Front Inner Curve

- PL133R/193/143/166 71"W x 101"D List \$2035



Bowfront L Desk

- PL189/145/166 71"W x 88"D List \$1393



Bowfront U-Station with Back Inner Curve

- PL189/193/182L/166 71"W x 112"D List \$1866

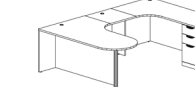

Bullet U-Station with Front and Back Inner Curves

- PL133R/195/182L/166 71"W x 102"D List \$2134

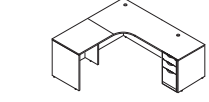

Corner Station with Inner Curve

- PL182L/192/166 71"W x 71"D List \$1330
- PL181L/179/166 66"W x 66"D List \$1292



Bowfront U-Station with Front and Back Inner Curves

- PL177R/195/182L/166 71"W x 108"D List \$2113

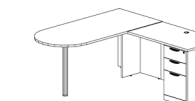

Bullet L Desk

- PL131/196/166 66"W x 72"D List \$1294

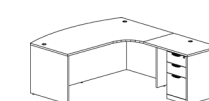

Bowfront L Desk with Inner Curve

- PL177R/192/166 71"W x 83"D List \$1594

Available Finishes



*Maple – please call for availability.

For detailed product information and options, please contact your sales representative.

WHITE

CLASSIC LAMINATE SERIES



Workplace Shown: PL143, PL196, PL144OH, PL107, GBM1769 List \$1943

FEATURES

- PVC Tough Edge on all exposed edges
- Top quality Steel Ball Bearing Drawer Slides
- Metal connections for increased durability
- Scalloped drawer pulls for an enhanced look
- Core removable locks, grommets and leveling glides included
- Soft close hinges and drawers



WHT Swatch



Includes Silver Scalloped Pulls

Edge Details



PVC Tough Edge

Hutch Options



See Pages 20-21

Tackboard Options



See Page 20

Handle Options



See Page 19



WHITE

CLASSIC LAMINATE SERIES



FOR MATCHING STORAGE + ACCESSORIES
see pages 19-21

Workplace Shown: PL101, PL170, PL143, PL166(1), PL144OH, PL44LD, PL118FOSS, 33DBLUAUCCG, PL156(2), PLBCDK(2) List \$4056



Workstation Shown: PL189, PL197, PL143, PL166(1), PL1440H, 44LD(2)
List \$2441



Workstation Shown: PL182L/R, PL192, PL107
List \$1184



Workstation Shown: PL189, PL166
List \$1076



Workstation Shown: PL102, PL145, PL107
List \$1149



Workstation Shown: PL189, PL197, PL143, PL166(1)
List \$1790

WHITE

CLASSIC LAMINATE SERIES



PL105(2), PL192(2), PL107(2) List \$2230

White Laminate Component Guide



Desk Shell
 PL101 71"W x 36"D List \$501
 PL105 71"W x 30"D List \$501
 PL102 66"W x 30"D List \$470
 PL103 60"W x 30"D List \$428
 PL121 48"W x 30"D List \$413



Credenza Shell
 PL143 71"W x 24"D List \$452
 PL111 66"W x 24"D List \$437
 PL129 60"W x 24"D List \$424
 PL142 half leg List \$90



Bridge
 PL170 48"W x 24"D List \$265
 PL197 42"W x 24"D List \$262
 PL193 35.5"W x 24"D List \$220



Deluxe Pedestal - Full (15.75"W)
 Unfinished Top
 PL166 2 Box / File 22"D List \$508
 PL175 File / File 22"D List \$508



Bow Front Desk Shell
 PL189 - 71"W x 36/41D List \$568
 PL187 - 66"W x 30/36D List \$563

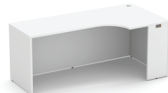

Credenza w/Corner Ext.
 PL182 R (shown) or L 71"W x 24/36"D List \$570
 PL181 R (shown) or L 66"W x 24/36"D List \$541



Hanging Pedestal - 3/4 (15.75"W)
 Unfinished Top
 PL107 Box / File 22"D List \$362



2-Drawer Lateral File 29"H With Removable Top
 PL112 36"W x 22"D List \$834

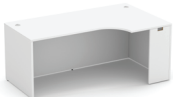

Desk Shell w/Corner Ext.
 PL178 R (shown) or L 71"W x 30"x 42"D List \$834



Return - Reversible
 PL145 48"W x 24"D List \$317
 PL196 42"W x 24"D List \$313
 PL192 35.5"W x 24"D List \$252
 PL179 30"W x 24"D List \$243



Open Hutch 15"D x 36"H
 PL141OH 60"W List \$510
 PL140OH 66"W List \$521
 PL144OH 71"W List \$541

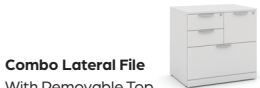

Combo Lateral File With Removable Top
 PL114 Box / Box / File w/1 Lot. 31"W x 22"D x 29"H List \$834

Hinged Laminate Doors For Open Hutch (set of 2 doors)
 PL41LD for PL141OH List \$55
 PL40LD for PL140OH List \$55
 PL44LD for PL144OH List \$55

FOR MATCHING STORAGE
 see pages 19



Bag Hooks



Bag Hook: Fit on all 1" thick Performance Laminate work surfaces
PLTBH List \$41

Complete Keyboard Systems



EZ0021 20"W Deluxe Keyboard Tray with Adjustable Mouse Surface and Padded Wristrest
List: \$313

Optional EZ0021 Adapter to use with Elements Series or Height Adjustable Tables. EZ6003 List: \$42



EZ0021-SL 20"W Deluxe Keyboard Tray with Adjustable Mouse Surface and Padded Wristrest with Extended Arm Mechanism.
List: \$397



EZ0046 28"W Premium Extra Wide 28" Pull-out Keyboard tray with Wrist rest.
List: \$174



EZ0036 21"W Pull-out Keyboard Tray with Reversible Mouse Surface and Wrist rest.
List: \$159

LED Task Lights

Add a task light to any hutch.

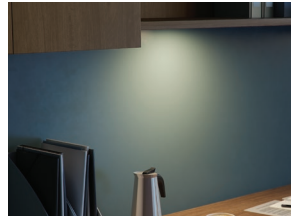

LED Task Lights
Model No. PLEDTL24 - 24"W List \$263

Square Grommet Cover

Fits in all Performance Laminate Grommet holes.
Square Grommet Cover



Silver - Model No. PLSQGRMSI List \$28
Black - Model No. PLSQGRMBK List \$28

Center Drawer

This low profile center drawer attaches to any work surface. Features ball-bearing suspensions.



Center Drawer
Model No. CDR1
(21 1/4"W x 16 1/2"D) List: \$97

Personal Drawer



Metal Personal Drawer
Silver or Black
PLTPMD 19"W x 10 1/4"D x 2 3/8"H
List \$125

Hawk Gas-Spring Monitor Arms

Experience unmatched ergonomics with our Hawk Monitor Arms. These arms boast a 360-degree rotation capability, effortlessly moving (or tilting) to any preferred position. Charge your devices conveniently with the integrated two USB ports. Customize your installation with the option of a clamp or grommet mount.



Includes 1 USB 3.0 port and 1 USB-C port



Clamp Mount Included



360° Rotation Capability



Grommet Mount Included

- Single + dual gas-spring monitor arm
- Freely adjustable height
- Cable management system

- Tilt: +85°/-30°
- VESA: 3x3 - 4x4 inches
- Max screen size 17"H x 30"W
- Weight capacity: 4.4 - 20 lbs

A. Hawk Dual Monitor Arm
Model No. 33DBLUAUCCG-BLK
List \$220

B. Hawk Single Monitor Arm
Model No. 33SGLUAUCCG-BLK
List \$140



ELEMENTS LAMINATE SERIES



Workstation Shown: PLT3072(2), PLT2448(2), PLTLEGU30(4), PLTLEGU24(2), PLT-MAINDESKBEAM72(2), PLT-RETSUPPORT(2), PL1007(2), PL207(2) List \$6226

INTRODUCING THE ELEMENTS LAMINATE SERIES: Simple, Contemporary, Affordable. Features include heavy duty steel frame and your choice of laminate finishes.

Available Finishes



*Maple – please call for availability.

FEATURES

- PVC Tough Edge on all exposed edges
- Choice of laminate finishes
- Top quality Steel Ball Bearing Drawer Slides
- Metal connections for increased durability
- Scalloped drawer pulls or Square drawer handles for an enhanced look (see page 19)
- Core removable locks, grommets and leveling glides included

Coordinates with all Classic Laminate Casegoods

see pages 2-23



Workstation Shown: PLT3072, PLT2448, PLTLEGU30(2), PLTLEGU24, PLT-MAINDESKBEAM72, PLT-RETSUPPORT, PL208OH(2), PL44SGD(2), PL1007, 335GLUAUCCG-BLK List: \$3150

ELEMENTS LAMINATE SERIES



4 Person Workstation Shown: PLTLEGU48(3), PLT2472(4) PLTCBB(4) PLT-MAINDESKBEAM72(4), RCPSBF(4), RCPSBFMAGC(4), PLTSBUDMDUAL(2), PLTAP1554S(2)
List \$5512

For Divider Panels
see page 47

Leg Options



Black U Leg



Silver U Leg



Silver Loop Leg



White Loop Leg*

*White Loop Leg - please call for availability



new

Workstation Shown: PLT3672, PLTLEGU36(2), PLT-MAINDESKBEAM72 List \$1106



ELEMENTS LAMINATE SERIES



Workstation Shown: PLT2460(3), PL166(3), PL1066(3), PLTLEG-U-24NB41H(3), PLT-RETSUPPORT(3), PLTCBB(2) List \$3804



New PLT723624L Aerial View

new*

*PL248 Available Summer 2025

Workplace Shown: PLT723624L/R (Shown as L), PLT2436, PLTLEGU24(2), PLTLEGU36, PLTMAINDESKBEAM72, PLT-RETSUPPORT, 33DBLUAUCCG-BLK, PL248, PLPULL-RBK(3) List \$2386

For detailed product information and options, please contact your sales representative.

ELEMENTS LAMINATE SERIES



Workstation Shown: PLTLEGLP30 (2), PLTLEGLP24 , PLT3072, PLT2448, PLT-MAINDESKBEAM72, PLT-RETSUPPORT, PL1007 List \$1826

INTRODUCING THE LOOP LEG: Elevate your workspace with our sleek loop leg, designed to blend modern aesthetics with exceptional durability. Available in brushed silver or white finishes, it adds a polished, contemporary touch to any office setting.



For Modesty Panels
see page 47



Workstation Shown: PLT3072, PLT2472, PLT2448, PLTMAINDESKBEAM72(2), PLTUSUPPORT, PLTLEGLP24(2), PLTLEGLP30(2), PL1007, PL2044OH, PL44SGD, PLTAP1554S, PLTSDTM List \$3573



ELEMENTS PLUS LAMINATE SERIES



Workplace Shown: PL1012, PL1013, PL110, PLTDR2430, PLT3072, PLTLEGU30, GBM1769, PL208 (2), PL44LD, PLT-MAINDESKBEAM72, 33DBLUAUCCG-BLK List \$3636

FEATURES

- PVC Tough Edge on all exposed edges
- Top quality Steel Ball Bearing Drawer Slides
- Scalloped drawer pulls or Square drawer handles for an enhanced look (see page 19)
- Core removable locks and leveling glides included

Elements Plus Finishes

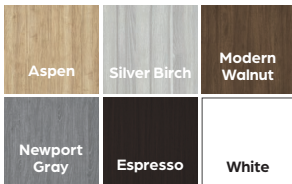

Leg Options



*White Loop Leg - please call for availability



Workstation Shown: PLT3072(2), PL1012(2), PL1013(2), PL110(2), PLTLEGU60, PLTLDR2430(2), PLT`CBBSILVER, PLT-MAINDESKBEAM72(2), PLTSMRLEG(4), PLTFP1554, PLTSBUDMDUAL List: \$5074



Workplace Shown: PL1012(4), PL1013(4), PL110(4), CUSH2136(4), PLTSMRLEG(8), PL1007(4), CUSH1522(4), PLTLEGU24(8), PLT2472(8), PLTLDR2430(4), PLT-MAINDESKBEAM72(4), PLT-RETURNBEAM72(4), PLTSBUDMDUAL(2), PLTAP1554S(2) List \$15,650

For detailed product information and options, please contact your sales representative.

ELEMENTS PLUS LAMINATE SERIES
Main Desk Tops
Available in Aspen, Modern Walnut, White, Cherry, Espresso, Silver Birch, Maple* & Newport Gray

		List
PLT2460	60"W x 24"D	\$236
PLT2472	72"W x 24"D	\$252
PLT3048	48"W x 30"D	\$243
PLT3060	60"W x 30"D	\$292
PLT3066	66"W x 30"D	\$313
PLT3072	72"W x 30"D	\$327
PLT3672	72"W x 36"D	\$392
PLT723624L/R**	72"W x 24-36"D	\$431

**PLT723624L/R only available in White, Aspen, Modern Walnut, Newport Gray & Silver Birch

Desk Beam Supports

		List
PLT-MAINDESKBEAM48	For 48" Desktop	\$77
PLT-MAINDESKBEAM60	For 60" Desktop	\$84
PLT-MAINDESKBEAM66	For 66" Desktop	\$97
PLT-MAINDESKBEAM72	For 72" Desktop	\$104

Return Tops
Available in Aspen, Modern Walnut, White, Cherry, Espresso, Silver Birch, Maple* & Newport Gray

		List
PLT2436	36"W x 24"D	\$174
PLT2442	42"W x 24"D	\$201
PLT2448	48"W x 24"D	\$225
PLT2460	60"W x 24"D	\$236
PLT2472	72"W x 24"D	\$252

Universal Return Support

		List
PLT-RETSUPPORT		\$42

For use with 36", 42" & 48" return top

Heavy Duty Return Beam Supports

		List
PLT-RETURNBEAM48	For use with 48" return top	\$97
PLT-RETURNBEAM60*	For use with 60" return top	\$111
PLT-RETURNBEAM66*	For use with 66" return top	\$119
PLT-RETURNBEAM72*	For use with 72" return top	\$126

*Not stocked in all locations

U-Configuration Support

		List
PLT-USUPPORT	For use with 42" or 48" Bridge	\$90

Support Leg (set of 2 legs)

		List
PLT-LEGUCSLF	For use with 48" and 60" legs	\$194

24"W - 36"W U Legs - Silver or Black

		List
PLTLEGU24	24"W x 28.5"H	\$216 ea
PLTLEGU30	30"W x 28.5"H	\$230 ea
PLTLEGU36	36"W x 28.5"H	\$305 ea

U Legs - Silver or Black
Connector Beam Bracket Required

		List
PLTLEGU48	48"W x 28.5"H	\$298 ea
PLTLEGU60	60"W x 28.5"H	\$340 ea
PLTLEGU2441H	24"W x 41"H	\$201 ea
PLTLEGU3041H	30"W x 41"H	\$216 ea
PLTLEGU4841H	48"W x 41"H	\$333 ea
PLTLEGUHALF		
Half support leg for 24" & 30" work surfaces		\$153 ea
PLTLEGU6041H	60"W x 41"H	\$369 ea
PLTLEGU4860IL	Benching inset leg	\$521 ea
PLTLEGU4860IL41	Benching inset leg 41"H	\$591 ea

All U Legs must be used with Desk or Return Support

Connector Beam Bracket - Silver or Black (Pair)

		List
PLTCBB	Required for use with half legs, 48" and 60" legs and all 41" high legs	\$90

Loop Legs - Silver or White**

		List
PLTLEGLP24	24"W x 28.5"H	\$216 ea
PLTLEGLP30	30"W x 28.5"H	\$230 ea

All Loop Legs must be used with Desk or Return Support

Support Rails

		List
PLT60MS	Top stiffener	\$46 ea
PLT72MS	Top stiffener	\$57 ea

Metal Pedestals - Silver, Black or White

		List
CPSBBF	Box/Box/File 15"W x 22"D x 26.5"H	\$535
CPSFF	File/File 15"W x 22"D x 26.5"H	\$535
CPPCaster	Set of 4 casters	\$34
CPSBF	Mobile Box/File 15"W x 22"D x 22.5"H	\$466
RCPSBF*	Box/File 12"W x 20"H x 20"D	\$485

*Only Available in White

Laminate Pedestals
Available in Aspen, Modern Walnut, Cherry, Espresso, Silver Birch, Newport Gray, Maple* & White

		List
PL166	Box/Box/File (without top)	\$508
15.75"W x 22"D x 28.5"H		

Laminate Open Pedestals

		List
PL1066	Open Pedestal	\$221
16"W x 22"D x 11.5"H		

Mobile Laminate Pedestals

		List
PL1007	Box/File 16"W x 22.5"D x 22.5"H	\$452
PL248*	2 Box / File (22" D) 15.5" W x 26.5" H	\$621
PL 249*	2 File (22" D) 15.5" W x 26.5" H	\$621

*Available Summer 2025

Laminate Storage
Available in Aspen, Modern Walnut, White, Espresso, Silver Birch & Newport Gray

		List
PL1012	2 Drawer Personal Cabinet (without top)	\$821
36"W x 22"D x 21"H		
PL1013	Open Bookcase (without top)	\$387
36"W x 22"D x 21"H		
PL109	36" File Top (for PL1012 or 1013)	\$132
PL110	71" Credenza Top (for PL1012 or 1013)	\$201

Pedestal Cushions
Available in Red, Green, Orange, Sky Blue, Gray and Visconti Fabric

		List
PLCUSH1522	Cushion for CPSBF or PL1007	\$132
PLCUSH2136	Cushion for PL1012 or PL1013	\$250

Metal Riser Leg - Silver or Black (set of 4)

		List
PLTSMRLEG	For use with PL1012 & PL1013 storage	\$108

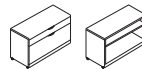
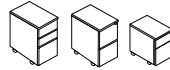
Hutch
Available in Aspen, Modern Walnut, White, Espresso, Silver Birch & Newport Gray

		List
PL1044OH-20	71" Open Hutch with 20"H support	\$779
PL1044OH-27	71" Open Hutch with 27"H support	\$821
PL44LD	2 Laminate Doors for Hutch	\$55
PL44LDLOCK	2 Locking Laminate Doors For Hutch	\$132
PL44SGD	Aluminum Frame Glass Doors for Hutch	\$207
PLTLPHSGSLIDE	Extension glide for 27" hutch support	\$20

Lower Desk Riser - Silver or Black

		List
PLTLDR2430	For use with PLTSMRLEG	\$139 ea

Desk Riser - Silver, Black or White**

		List
PLTDR2430	For 24" or 30" Depth	\$142 ea

Wall Mounted Storage

		List
PL208OH	36.5" Wall Mounted Open Cabinet	\$385
PL2044OH	71" Wall Mounted Open Cabinet	\$641

Magnetic Glass Privacy Dividers

		List
PLTGP1524S	24"W x 15"H	\$211
PLTGP1542S	42"W x 15"H	\$362
PLTGP1548S	48"W x 15"H	\$385
PLTGP1554S	54"W x 15"H	\$448

See page 47 for complete privacy divider selection

Acrylic Privacy Dividers

		List
PLTAP1524S	24"W x 15"H	\$159
PLTAP1530S	30"W x 15"H	\$172
PLTAP1536S	36"W x 15"H	\$180
PLTAP1542S	42"W x 15"H	\$188
PLTAP1548S	48"W x 15"H	\$201
PLTAP1554S	54"W x 15"H	\$216
PLTAP1566S	66"W x 15"H	\$236

Fabric Privacy Dividers

		List
PLTFP1542	42"W x 15"H	\$130
PLTFP1548	48"W x 15"H	\$151
PLTFP1554	54"W x 15"H	\$173

See page 47 for complete privacy divider selection

Divider/Screen Brackets - Silver or Black

		List
PLTSDTM	Universal Desk Mount Screen Bracket (pair)	\$63
PLTSBUDMSGL	Edge Mount Screen Bracket (pair)	\$81
PLTSBUDMDUAL	Dual Desk Mount Screen Bracket (pair)	\$81



ELEMENTS TYPICALS ORDERING GUIDE

The following configurations help provide a list of components required to ensure proper structure to your workstation. Choice of leg options are shown with each workstation example.

Leg Options

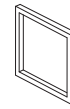

Loop Leg



U Leg

Typical Configurations



Standard Elements Plus 72" x 72" Workstation with Low Storage:
 PLT3072, PLTLLEGU30, PLT-MAINDESKBEAM72, PLTDR2430,
 PL1012, PL1013, PL110



Standard 72" x 72" Workstation with Return:
 PLT3072, PLTLLEGU30(2), PLT-MAINDESKBEAM72, PLT2442,
 PLTLLEGU24, PLT-RETSUPPORT



Standard 24" x 72" Workstation:
 PLT2472, PLTLLEGU24(2),
 PLT-MAINDESKBEAM72

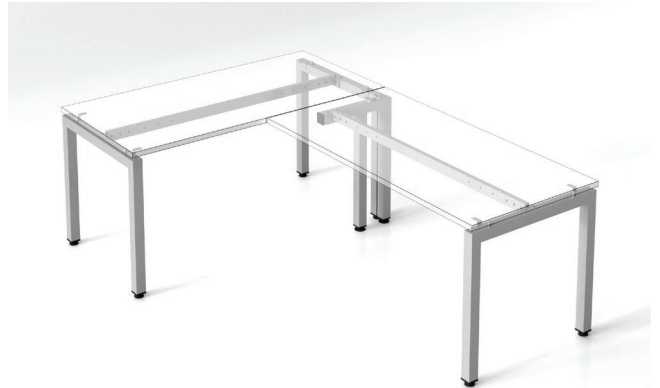

Standard 72" x 90" Workstation with Extended Return:
 PLT3072, PLTLLEGU30(3), PLT-MAINDESKBEAM72, PLT3060,
 PLTLLEGUHALF, PLT-MAINDESKBEAM60, PLTCBB



Standard 72" x 102" U-Group Workstation:
 PLT3072, PLTLLEGU30(2), PLT-MAINDESKBEAM72(2), PLT2472,
 PLTLLEGU24(2), PLT2448, PLT-USUPPORT



Standard 30" x 120" 2-Person Workstation with Half-Leg:
 PLT3060(2), PLTLLEGU30(2), PLTLLEGUHALF, PLT-MAINDESKBEAM60(2),
 PLTCBB. May require wall anchoring.



For detailed product information and options, please contact your sales representative.

Elements Work Surface Finishes



*Maple – please call for availability.

Elements Plus Finishes



ELEMENTS TYPICALS ORDERING GUIDE

Typical Configurations



Standard 60" x 72" 2-Person Benching Workstation:
 PLT3072(2), PLTLEGU60(2), PLT-MAINDESKBEAM72(2),
 PLTCBB(2)

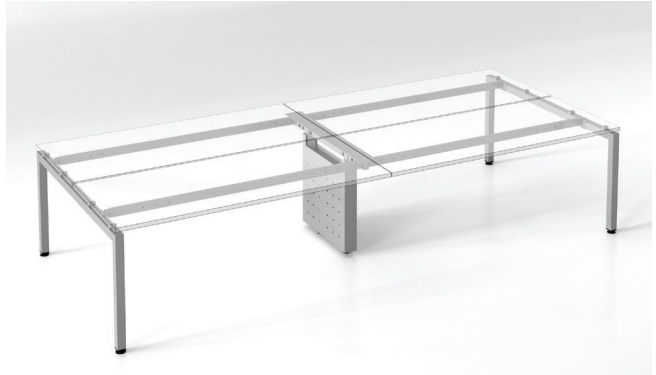

Standard 60" x 144" 4-Person Benching Workstation:
 PLT3072(4), PLTLEGU60(2), PLTEGU4860ILCMB,
 PLT-MAINDESKBEAM72(4), PLTCBB(2)



Typical Standing Height Configurations



Standard 30" x 72" Standing Height Workstation:
 PLT3072, PLTLEGU3041H(2), PLT-MAINDESKBEAM72(2),
 PLTCBB(2)



Standard 60" x 144" 4-Person Standing Height Benching Workstation:
 PLT3072(4), PLTLEGU6041H(2), PLTEGU4860ILCMB41H,
 PLT-MAINDESKBEAM72(6), PLTCBB(4)



Designer U Leg Metal End Panels



Designer Metal End Panel for 24" and 30" U Legs*
 PLTULEG-FMEPP24 for PLTLEGU24 List \$122
 PLTULEG-FMEPP30 for PLTLEGU30 List \$140

*Available only in Silver



Designer Metal End Panel for 48" and 60" U Legs*
 PLTULEG-FMEPP48 for PLTLEGU48 List \$259
 PLTULEG-FMEPP60 for PLTLEGU60 List \$296

*Available only in Silver

Personal Drawer



Metal Personal Drawer – Silver or Black
 PLTPMD 19"W x 10.25"D x 2 3/8"H

List \$125

For detailed product information and options, please contact your sales representative.



ENCORE COLLECTION



*PL248 Available Summer 2025

4 Person Workstation Shown: PLTLEGBEV60(3), PLTBBSINGLE(8), PLTADJMDB4872(4), PLT3072(4), PLTSBUDMDUAL(2), PLTAP1554S(2), PL248(4) List \$6701

INTRODUCING THE ENCORE COLLECTION: Simple, Contemporary, Affordable. Features include heavy duty beveled steel frame and your choice of laminate finishes. Works with Elements Series work surfaces and storage.

FEATURES

- PVC Tough Edge on all exposed edges
- Top quality Steel Ball Bearing Drawer Slides
- Core removable locks and leveling glides included

Available Work Surface Finishes

Aspen	Silver Birch	Newport Gray	Espresso
Modern Walnut	Cherry	White	Maple*

Available Storage Finishes

Aspen	Silver Birch	Modern Walnut
Newport Gray	Espresso	White

*Maple – please call for availability.



Workstation Shown: PLT3072, PL1013(2), PL1012(2), PL110, PL109, PL152, PLTBVELEG30, PLTADJMDB4872, PLTBBSINGLE, PLTDR2430, PL208OH(2), PLCUSH2136 List: \$5419



Workstation Shown: PLTLEGBEV30 (2), PLTBBSINGLE (2), PLT3072, PLTADJMDB4872, PL1012, PL1013, PL110, PL1044OH-27, PL44SGD List: \$3246

ENCORE COLLECTION



Encore Collection Component Guide

Workstation Shown: PLT3072, PL1012, PL1013, PL110, PL1044OH-27, PL44LD, PLTLEGBEV30, PLTBBSINGLE, PLTDR2430, PLTADJMDB4872, PULPULLR-BK(2), GBM1769, PLT-BH List \$3580

Main Desk Tops

Available in Aspen, Modern Walnut, White, Cherry, Espresso, Silver Birch, Maple* and Newport Gray

Part Number	Dimensions	List Price
PLT2460	60"W x 24"D	\$236
PLT2472	72"W x 24"D	\$252
PLT3048	48"W x 30"D	\$243
PLT3060	60"W x 30"D	\$292
PLT3066	66"W x 30"D	\$313
PLT3072	72"W x 30"D	\$327
PLT3672	72"W x 36"D	\$392
PLT723624L/R**	72"W x 24-36"D	\$431

**PLT723624L/R only available in White, Aspen, Modern Walnut, Newport Gray & Silver Birch

Adjustable Desk Beam Support

PLTADJMDB4872 Universal adjustable desk beam
For use with 60", 66" and 72" wide tops.

List Price
\$135

Return Tops

Available in Aspen, Modern Walnut, White, Cherry, Espresso, Silver Birch, Maple* and Newport Gray

Part Number	Dimensions	List Price
PLT2436	36"W x 24"D	\$174
PLT2442	42"W x 24"D	\$201
PLT2448	48"W x 24"D	\$225
PLT2460	60"W x 24"D	\$236
PLT2472	72"W x 24"D	\$252

Adjustable Return Beam Support

PLTADJRB6072 For use with 60" and 72" return tops
Must be used with PLTRBBFP

PLTRBBFP Receiver bracket for PLTADJRB6072

List Price
\$149
\$47

Return Support Bracket

PLT-BBBRETSUPPORT
Support bracket for up to 48" return top

List Price
\$47

U-Configuration Support

PLT-USUPPORT For use with 42" or 48" Bridge

List Price
\$90

Riser Leg - Black (set of 4 legs)

PLTSMRLEG For use with PL1012 & PL1013 storage

List Price
\$108

Bevel Legs - Black

PLTLEGBEV24 24"W x 28.5"H
PLTLEGBEV30 30"W x 28.5"H
PLTLEGBEV48 48"W x 28.5"H
PLTLEGBEV60 60"W x 28.5"H



All Bevel Legs must be used with Desk or Return Support and Connector Beam Bracket.

List Price
\$265 ea
\$294 ea
\$437 ea
\$477 ea

Connector Beam Bracket - Black

PLTBBSINGLE
Required for use with each Bevel Leg



List Price
\$43

Support Rails

PLT60MS Top stiffener
PLT72MS Top stiffener

List Price
\$46 ea
\$57 ea

Desk Risers - Black

PLTDR2430 For 24" or 30" Depth



List Price
\$142 ea

Lower Desk Riser - Black

PLTLDR2430 For use with PLTSMRLEG



List Price
\$139 ea

Hutch

Available in Aspen, Modern Walnut, White, Espresso, Silver Birch & Newport Gray

Part Number	Description	List Price
PL1044OH-20	71" Open Hutch with 20"H support	\$779
PL1044OH-27	71" Open Hutch with 27"H support	\$821
PL44LD	2 Laminated Doors for Hutch	\$55
PL44LDLOCK	2 Locking Laminated Doors For Hutch	\$132
PL44SGD	Aluminum Frame Glass Doors for Hutch	\$207

List Price
\$779
\$821
\$55
\$132
\$207

Metal Pedestals - Black

CPSBF Mobile Box/File
15"W x 22"D x 22.5"H



List Price
\$265 ea
\$294 ea
\$437 ea
\$477 ea

List Price
\$466

Mobile Laminate Pedestals

Available in Aspen, Modern Walnut, Cherry, Espresso, Silver Birch, Newport Gray, Maple* & White

Part Number	Description	List Price
PL1007	Mobile Box/File 16"W x 22.5"D x 22.5"H	\$452
PL248*	2 Box / File (22" D) 15.5" W x 26.5" H	\$621
PL249*	2 File (22" D) 15.5" W x 26.5" H	\$621

*Available Summer 2025



Laminate Storage

Available in Aspen, Modern Walnut, White, Espresso, Silver Birch & Newport Gray

Part Number	Description	List Price
PL1012	2 Drawer Personal Cabinet (without top) 36"W x 22"D x 21"H	\$821
PL1013	Open Bookcase (without top) 36"W x 22"D x 21"H	\$387
PL109	36" File Top (for PL1012 or 1013)	\$132
PL110*	71" Credenza Top (for PL1012 or 1013)	\$201

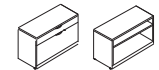

Pedestal Cushions

Available in Red, Green, Orange, Sky Blue, Gray and Visconti Fabric

Part Number	Description	List Price
PLCUSH1522	Cushion for PL1007	\$132
PLCUSH2136	Cushion for PL1012 or PL1013	\$250

Metal Personal Drawer - Silver or Black

PLTPMD 19"W x 10.25"D x 2.375"H

List Price
\$125



SIGNATURE METAL LEG COLLECTION



INTRODUCING THE SIGNATURE METAL LEG COLLECTION:
Simple, Contemporary, Affordable. Features include heavy duty VA steel frame and your choice of laminate finishes. Works with Elements Series work surfaces and storage.

4 Person Workstation Shown: PLT3072(4), PL1012(4), PL1013(4), PL110(4), PLTVALEGMOUNT4860(2), PLTVAMETLEG(2), PLT-MAINDESKBEAM72(4), PLTLDR2430(4), PLTAWRLEG(8), PLTAP1554S(2), PLTSBUDMDUAL(2) List \$10,028

FEATURES

- PVC Tough Edge on all exposed edges
- Top quality Steel Ball Bearing Drawer Slides
- Core removable locks and leveling glides included

Laminate Finishes



*Cherry and Maple – please call for availability

Metal Leg Options



Black VA Leg



Silver VA Leg



Workstation Shown: PLT3072(6), PL1012(6), PL109(6), PLCUSH2136(6), PLTVALEGMOUNT4860(6), PLTVAMETLEG(6), PLT-MAINDESKBEAM72(6), PLTAP1554S(3), PLTSBUDMDUAL(3) List: \$12,657



Workstation Shown: PLT2472(2), PL1012(2), PL1013(2), PL110(2), PL1007(2), PLCUSH1522(2), PLTVALEGMOUNT2430(2), PLTVAMETLEG(2), PLTLDR2430(2), PLT-MAINDESKBEAM72(2), PL1044OH-27(2), PL44LD(2) List: \$7300

For detailed product information and options, please contact your sales representative.

SIGNATURE METAL LEG COLLECTION



New PLT723624L Aerial View

Workstation Shown: PLTVALEGMOUNT2430(2), PLTVALEGMOUNT3642, PLTVAMETLEG(3), PLT-RETSUPPORT, PLT-MAINDESKBEAM72, PLT723624L/R (Shown as L), PLT2436, 33SGLUAUCCGBLK, RCPSBF, RCPSBFMAGC List \$2156



Workstation Shown: PLTVALEGMOUNT3642(2), PLTVAMETLEG(2), PLT-MAINDESKBEAM72, PLT3672, RCPSBF, 33DBLUAUCCGBLK List \$1735



SIGNATURE WOOD LEG COLLECTION



INTRODUCING THE SIGNATURE WOOD LEG COLLECTION: Simple, Contemporary, Affordable. Features include solid wood VA legs with steel mounting brackets and your choice of laminate finishes. Works with Elements Series work surfaces and storage.

Workstation Shown: PLT3072(2), PL1012(2), PL1013(2), PL110(2), PLTVALEGMOUNT4860, PLTVARWLEG, PLTLDR2430(2), PLTAWRLEG (4), PLPULLR-RSI(4), PLT-MAINDESKBEAM72(2), 33DBLUAUCCGBLK
List \$5056

FEATURES

- PVC Tough Edge on all exposed edges
- Top quality Steel Ball Bearing Drawer Slides
- Core removable locks and leveling glides included

Available Work Surface Finishes

Aspen	Silver Birch	Newport Gray	Espresso
Modern Walnut	Cherry	White	Maple*

Available Storage Finishes

Aspen	Silver Birch	Modern Walnut
Newport Gray	Espresso	White

*Maple – please call for availability.

Wood Leg Options



Modern Walnut with Black Mount



Natural with Black Mount



Newport Gray with Black Mount



Modern Walnut with Silver Mount



Natural with Silver Mount



Newport Gray with Silver Mount



Workstation Shown: PLT3072, PL1012, PL1013, PL110, PLTVALEGMOUNT2430, PLTVARWLEG, PLT-MAINDESKBEAM72, PLTLDR2430, PLTAWRLEG(2), PLPULLR-SI(2) List \$2489

For detailed product information and options, please contact your sales representative.

SIGNATURE WOOD LEG COLLECTION



Workstation Shown: PLT2472(4), PL1012(4), PLCUSH2136(4), PL1013(4), PL110(4), PLTVALEGMOUNT4860(2), PLTVARWLEG(2), PLT-MAINDESKBEAM72(4), PLTLDR2430(4), PLTAWRLEG(8), 33DBLUAUCCGBLK(2), PLPULLR-BK(8) List: \$10,812



Workstation Shown: PLT3072(4), PLTVALEGMOUNT4860(3), PLTVARWLEG(3), PLT-MAINDESKBEAM72(4), PLTMBMBC, PLTAP1554S(2), PLTSBUDMDUAL(2), PL112(3), PL153(3) List: \$7089



SIGNATURE METAL AND WOOD LEG COMPONENT GUIDE

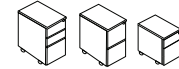

Main Desk Tops		List
Available in Aspen, Modern Walnut, White, Cherry, Espresso, Silver Birch, Maple* and Newport Gray		
PLT2448	48"W x 24"D	\$225
PLT2460	60"W x 24"D	\$236
PLT2472	72"W x 24"D	\$252
PLT3048	48"W x 30"D	\$243
PLT3060	60"W x 30"D	\$292
PLT3066	66"W x 30"D	\$313
PLT3072	72"W x 30"D	\$327
PLT3672	72"W x 36"D	\$392
PLT723624L/R**	72"W x 24-36"D	\$431

**PLT723624L/R only available in White, Aspen, Modern Walnut, Newport Gray & Silver Birch

Main Desk Beam Supports		List
PLT-MAINDESKBEAM48	For 48" Desktop	\$77
PLT-MAINDESKBEAM60	For 60" Desktop	\$84
PLT-MAINDESKBEAM66	For 66" Desktop	\$97
PLT-MAINDESKBEAM72	For 72" Desktop	\$104

Return Tops		List
Available in Aspen, Modern Walnut, White, Cherry, Espresso, Silver Birch, Maple* and Newport Gray		
PLT2436	36"W x 24"D	\$174
PLT2442	42"W x 24"D	\$201
PLT2448	48"W x 24"D	\$225
PLT2460	60"W x 24"D	\$236
PLT2472	72"W x 24"D	\$252

Universal Return Support		List
PLT-RETSUPPORT	For use with 36", 42" & 48" return top	\$42

Heavy Duty Return Beam Supports		List
PLT-RETURNBEAM48	For use with 48" return top	\$97
PLT-RETURNBEAM60*	For use with 60" return top	\$111
PLT-RETURNBEAM66*	For use with 66" return top	\$119
PLT-RETURNBEAM72*	For use with 72" return top	\$126

*Not stocked in all locations

U-Configuration Support		List
PLT-USUPPORT	For use with 42" or 48" Bridge	\$90

Angled Wood Leg (set of 4 legs)		List
PLTAWRLEG	For use with PL1012 & PL1013 storage	\$111

Available in Modern Walnut, Natural and Newport Gray

Metal Leg - Silver or Black (set of 4 legs)		List
PLTSMRLEG	For use with PL1012 & PL1013 storage	\$108

Wood or Metal VA Legs		List
Available in Silver or Black		
Must be used with PLTVAEGMOUNT		
PLTVARWLEG	Leg pack	\$139
Available in Modern Walnut, Natural & Newport Gray		
PLTVAMETLEG	Leg pack	\$108



VA Leg Mount- Silver or Black		List
PLTVAEGMOUNT2430	for 24" or 30" deep workstations	\$111
PLTVAEGMOUNT3642	for 36" or 42" deep workstations	\$159
PLTVAEGMOUNT4860	for 48" or 60" deep workstations	\$219
Must be used with PLTVALEG		



VA Leg Ganging Connector Bracket		List
PLTMBMBC	Pair of Ganging Brackets for PLTVAEGMOUNT4860	\$49

VA Tall Legs - Silver or Black		List
PLTVAMETLEG41	41"H VA Leg pack	\$140 ea
Must be used with PLTVAEGMOUNT & Cross Brace		

VA Tall Leg Cross Brace - Silver or Black		List
PLTVA243041CB	Cross Brace for 2430 41" VA Leg	\$43
PLTVA486041CB	Cross Brace for 4860 41" VA Leg	\$80

Bookcase Desk Kit		List
PLTBKDK30	Brackets to attach work surface to bookcase	\$18 ea



Hutch		List
Available in Aspen, Modern Walnut, White, Espresso, Silver Birch & Newport Gray		
PL1044OH-20	71" Open Hutch with 20"H support	\$779
PL1044OH-27	71" Open Hutch with 27"H support	\$821
PL44LD	2 Laminate Doors for Hutch	\$55
PL44LDLOCK	2 Locking Laminate Doors For Hutch	\$132
PL44SGD	2 Aluminum Frame Glass Doors for Hutch	\$207

Metal Pedestals - Silver, Black or White		List
CPSBBF	Box/Box/File 15"W x 22"D x 26.5"H	\$535
CPSFF	File/File 15"W x 22"D x 26.5"H	\$535
CPPCaster	Set of 4 casters	\$34
CPSBF	Mobile Box/File 15"W x 22"D x 22.5"H	\$466
RCPSBF*	Box/File 12"W x 20"H x 20"D	\$485

*Only Available in White

Laminate Pedestals		List
Available in Aspen, Modern Walnut, Cherry, Espresso, Silver Birch, Newport Gray, Maple* & White		
PL166	Box/Box/File (without top) 15.75"W x 22"D x 28.5"H	\$508



Mobile Laminate Pedestals		List
PL1007	Box/File 16"W x 22.5"D x 22.5"H	\$452
PL248*	2 Box/File (22" D) 15.5" W x 26.5" H	\$621
PL 249*	2 File (22" D) 15.5" W x 26.5" H	\$621

*Available Summer 2025



Laminate Storage		List
Available in Aspen, Modern Walnut, White, Espresso, Silver Birch & Newport Gray		
PL1012	2 Drawer Personal Cabinet (without top) 36"W x 22"D x 21"H	\$821
PL1013	Open Bookcase (without top) 36"W x 22"D x 21"H	\$387
PL109	36" File Top (for PL1012 or 1013)	\$132
PL110	71" Credenza Top (for PL1012 or 1013)	\$201

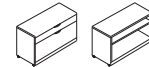

Pedestal Cushions		List
Available in Red, Green, Orange, Sky Blue, Gray and Viscotti Fabric		
PLCUSH1522	Cushion for CPSBF or PL1007	\$132
PLCUSH2136	Cushion for PL1012 or PL1013	\$250

Lower Desk Riser - Silver or Black		List
PLTLDR2430	For use with PLTAWRLEG	\$139



Desk Risers - Silver or Black		List
PLTDR2430	For 24" or 30" Depth	\$142 ea



Riser Legs

Metal Leg Options



Silver Black

Wood Leg Options



Modern Walnut Natural Newport Gray

Tall Metal Legs

- PVC Tough Edge on all exposed edges
- Leveling guides included



Black VA Tall Leg



Silver VA Tall Leg

Power Management Leg



Optional Wood Power Management VA Leg
 PLTECVARWLEG Single Leg List \$119
 Available in Modern Walnut, Natural and Newport Gray.

SIGNATURE METAL LEG COLLECTION



INTRODUCING THE SIGNATURE METAL LEG COLLECTION: Simple, Contemporary, Affordable. Features include heavy duty VA steel frame and your choice of laminate finishes.

4-Person Workstation Shown: PLT3072(2), PLTVALEGMOUNT4860(2), PLTVAMETLEG41(2), PLTV486041CB(2), PLT-MAINDESKBEAM72(3)
List: \$1844

Typical Configurations



Standard 48" x 60" 2-Person Benching Workstation: PLT2460(2), PLTVALEGMOUNT4860(2), PLTVALEG(2), PLT-MAINDESKBEAM60(2)



Standard 30" x 72" Workstation: PLT3072, PLTVALEGMOUNT2430(2), PLTVALEG(2), PLT-MAINDESKBEAM72



Standard 30" x 72" Workstation: PLT3072, PLTVALEGMOUNT2430, PLTVALEG, PL110, PLT-MAINDESKBEAM72, PLTDR2430, PL1012, PL1013



Standard 144" x 60" 4-Person Benching Workstation: PLT3072(4), PLTVALEGMOUNT4860(2), PLTVALEG(2), PLT-MAINDESKBEAM72(4), PLTLEGU4860IL

Available Work Surface Finishes



*Maple – please call for availability.

Available Storage Finishes

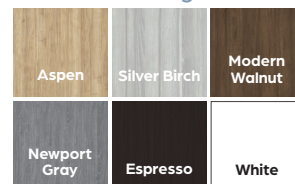

ELEMENTS SERIES POWER ACCESSORIES

Elements Series Power

Performance Furnishings has partnered with ECA to offer full power integration to all Performance desk series. Please contact your Sales Associate for more information or a quote.

Professional installation required.

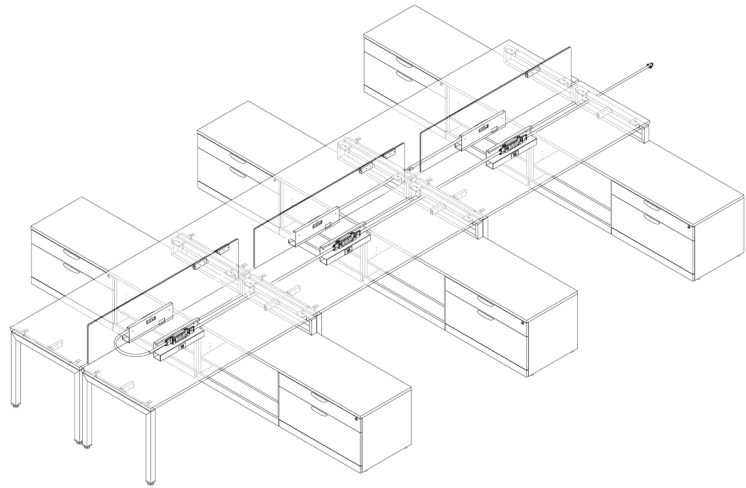

Power Block with Receptacles		List
ECA84AA	Double Sided Power Block with Mounting Bracket	\$105
ECA84S1BL150	Receptacle 1	\$30
ECA84S2BL150	Receptacle 2	\$30
ECA84S4BL150	Receptacle 4	\$30
ECA84SIGOR150	Isolated Ground Receptacle 3	\$34
ECA8SR	Receptacle Removal Tool	\$11



Harnesses		List
ECA84FF23	Harness - 23"	\$223
ECA84FF35	Harness - 35"	\$251
ECA84FF41	Harness - 41"	\$266
ECA84FF53	Harness - 53"	\$302
ECA84FF64	Harness - 64"	\$331
ECA84FF71	Harness - 71"	\$344

Other sizes available by special order, please call for more information.



Starter Harnesses		List
ECA84SB272	Hardwire Starter Harness 72"	\$317
ECA84SB2144	Hardwire Starter Harness 144"	\$504
ECA84FM24	Female/Male Jumper 8 Wire, 4 Circuit System. Must be hardwired by a Licensed Electrician.	\$225

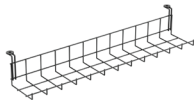

Wire Rack
PLTWSINGLE24BLACK List \$49
PLTWTDOUBLE24BLACK List \$65



Under Desk Cord Manager
PLTPWM18-BLK 18" List \$32



Metal Channel
PLTPC18BLACK List \$80
Accommodates your own power source or ECA UTD Series

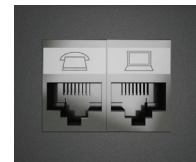

Data Plates
ECAABLAB RJ11/RJ45 List \$209
ECAABLBB with 2 RJ45 List \$274
Call for availability

Under Surface Mount Power Center

Under Surface Mount Power Center - Linkable
Compact design mounts under the edge of work surface. Features 3 power outlets, 1 USB charging port and 1 USB-C charging port. 9' power cord, 40" USB cable. Linkable. Stocked in Black. Model No. PPB3E1U1UCSPBLK List \$231



Power Modules

Desk Mount Power Module
Linkable - can be mounted above or below work surface. Features 2 power outlets and 2 USB charging ports. Includes 10' power cord and 6' linking cord. Stocked in White or Black. Model No. PLTDTPM2UEG List \$323



Conference Power Hub
Features 5 power outlets and 4 USB charging ports. 8' power cord with surge protector. Stocked in White. Model No. PPD5E4U List \$365



Power Center

Power Center
Fits 2.25" Grommet hole. Features 1 power outlet and 1 USB connection with optional data or charge. 5' power cord, 40" USB cable. Stocked in Black. Model No. PPGEUABLK List \$138

Pull-Out Power Grommet

Hidden pull-out power center. Fits 2.25" Grommet hole. Features 4 power outlets and 2 USB charging ports. 6' heavy duty power cord with surge protector. Stocked in Black.



Model No. PPGP04E2UBLK List \$181



MODESTY PANELS + PRIVACY SCREENS

Modesty Panels



Acrylic Modesty Panels		List
PLTAP1524S	24"W x 15"H	\$159
PLTAP1530S	30"W x 15"H	\$172
PLTAP1536S	36"W x 15"H	\$180
PLTAP1542S	42"W x 15"H	\$188
PLTAP1548S	48"W x 15"H	\$201
PLTAP1554S	54"W x 15"H	\$216
PLTAP1566S	66"W x 15"H	\$236

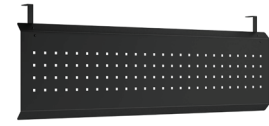
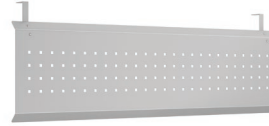

Perforated Metal Modesty Panels		
MMP1865PERF	65"W x 18"H	to fit 72" wide Workstations List \$162
MMP1853PERF	53"W x 18"H	to fit 60" wide Workstations List \$149
MMP1841PERF	41"W x 18"H	to fit 48" wide Workstations List \$125

Privacy Screens

Our privacy screens/modesty panels can be mounted above or below most work surfaces with our designer mounting bracelets. Acrylic and fabric options to suit the modern environment. Your choice of Magnetic Glass, Frosted Acrylic, Clear Acrylic or Fabric.

Fabric Panel Finishes

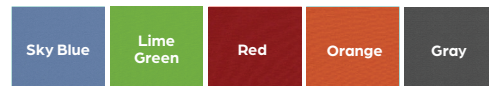

Magnetic Glass



Frosted Acrylic



Clear Acrylic

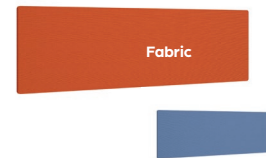

Fabric

15" High Magnetic Glass Privacy Screens
Can be mounted above work surface only

PLTGP1524S	24"W x 15"H	\$211
PLTGP1542S	42"W x 15"H	\$362
PLTGP1548S	48"W x 15"H	\$385
PLTGP1554S	54"W x 15"H	\$448

15" High Frosted Acrylic Privacy Screens
Can be mounted above or below work surface

PLTAP1524S	24"W x 15"H	\$159
PLTAP1530S	30"W x 15"H	\$172
PLTAP1536S	36"W x 15"H	\$180
PLTAP1542S	42"W x 15"H	\$188
PLTAP1548S	48"W x 15"H	\$201
PLTAP1554S	54"W x 15"H	\$216
PLTAP1566S	66"W x 15"H	\$236

24" High Clear Acrylic Privacy Screens
To be mounted above work surface.
Must be used with PLTSBUDMSGSL or PLTSBUDMDUAL Mounting Brackets.

PLTAP2424SCLR	24"W x 24"H	List \$182
PLTAP2430SCLR	30"W x 24"H	List \$196
PLTAP2460SCLR	60"W x 24"H	List \$304
PLTAP2472SCLR	72"W x 24"H	List \$344

Fabric Privacy Dividers
Can be mounted above or below work surface

PLTFP1542	42"W x 15"H	\$130
PLTFP1548	48"W x 15"H	\$151
PLTFP1554	54"W x 15"H	\$173

Available in Lime Green, Sky Blue, Red, Orange & Gray

Mobile Privacy Screen

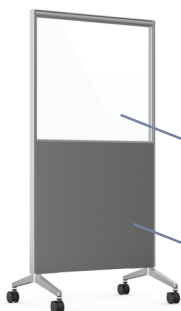

Mobile Privacy Screen
PPP3663SICHARCLR
36"W x 63"H
List \$844

Clear Acrylic

Charcoal Laminate

Panel Mounting Brackets

To be used with 1" thick work surfaces.
Available in Silver or Black.



PLTSDTM Universal Desk Mount Screen Bracket (pair)
Can be mounted in any position, above or below work surface
\$63



PLTSBUDMSGSL Edge Mount Screen Bracket (pair)
Can be used above or below work surface
\$81



PLTSBUDMDUAL Dual Desk Mount Screen Bracket (pair)
To be used for a single privacy panel between two shared work surfaces
\$81

RISER DESKING SERIES



Riser Series Available Summer 2025

INTRODUCING THE RISER DESKING SERIES: where premium laminate meets rustic wire-metal modesty panels, offering a contemporary-meets-industrial aesthetic. Our Riser series allows you to create the perfect desk configuration to suit your needs—whether it’s a single, L-shape, or U-shape setup. Designed to bring functionality and style to any office space, Riser is the perfect choice for today’s evolving work environments.

FEATURES

- PVC Tough Edge on all exposed edges
- Top quality Steel Ball Bearing Drawer Slides
- Metal connections for increased durability
- Square drawer pulls for a premium look
- Core removable locks, grommets and leveling glides included
- Soft close pedestal doors

Available Work Surface Finishes



*Maple – please call for availability.

Pedestal Finish



Metal Finish



RISER DESKING SERIES



Riser Series Available Summer 2025



Double Pedestal Desk w/ Modesty

Model#	Description	List
RISSD1000	24" x 60" Double Pedestal Riser Desk	\$1335
RISSD1002	24" x 72" Double Pedestal Riser Desk	\$1375
RISSD1003	30" x 60" Double Pedestal Riser Desk	\$1510
RISSD1005	30" x 72" Double Pedestal Riser Desk	\$1570



L-Shape Desk w/ Modesty Panels

Model#	Description	List
RISLD1000	24" x 60" Desk w/ 24" x 42" Return	\$1955
RISLD1002	24" x 72" Desk w/ 24" x 42" Return	\$1995
RISLD1003	30" x 60" Desk w/ 24" x 42" Return	\$2095
RISLD1005	30" x 72" Desk w/ 24" x 42" Return	\$2155

U-Shape Desk w/ Modesty Panels*

Model#	Description	List
RISUD1003	30" x 60" Desk & Credenza w/ 24" x 48" Bridge	\$3050
RISUD1005	30" x 72" Desk & Credenza w/ 24" x 48" Bridge	\$3130

*U-Shape Riser Desks come with 2 x Box/File Pedestals and 2 x Open Pedestals





HEIGHT ADJUSTABLE DESK



Workstation Shown: PLT3072, HADSD5001N, PL112, PL113, PL110, PL1044OH-27, PL44SGD, PLTAP1554S, PLTSDTM List: \$5223

INTRODUCING THE EXECUTIVE LAMINATE HEIGHT ADJUSTABLE DESK: Get the executive desk look with today's ergonomic benefits. Performance Height Adjustable Tables can help promote a healthier and more efficient workplace.

FEATURES

- PVC Tough Edge on all exposed edges
- Coordinating or contrasting top and desk base finishes
- Cord management

Available Desk & Top Finishes

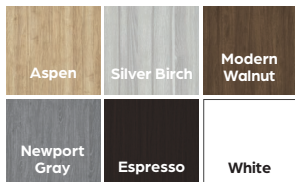

Available Electric Base Finishes

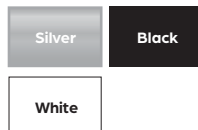

Professional installation recommended.



PLT3072, HADSD5001N, PL143, PL145, PL142, PL166, PLTAP1554S, PLTSDTM List \$3672



A.

B.

A. 30" x 72" Work Surface

Model No. PLT3072
Available in Aspen, Espresso, Modern Walnut, White, Newport Gray, and Silver Birch.
List: \$327

B. Deluxe Electric Height Adjustable Desk Base

Model No. HADSD5001N
Features 3 stage legs, 2 motors. Height range with top 25.5" to 51". Weight rating 265 lbs. Features anti-collision protection and programmable memory handset. Adjustable glides. Laminate base available in Aspen, Espresso, Modern Walnut, White, Newport Gray, and Silver Birch. Height adjustable legs available in Silver, White & Black.
List: \$1978



HEIGHT ADJUSTABLE DESK



Laminate Tops

Model#	Description	List
PLT2448	24" x 48"	\$225
PLT2460	24" x 60"	\$236
PLT2472	24" x 72"	\$252
PLT3048	30" x 48"	\$243
PLT3060	30" x 60"	\$292
PLT3066	30" x 66"	\$313
PLT3072	30" x 72"	\$327
PLT3672	36" x 72"	\$392
PLT723624L/R**	24-36" x 72"	\$431

Available Work Surface Finishes



*Maple – please call for availability.

Available Base Finishes



*White not available on standard table base

Bevel-Edge Laminate Tops



Model#	Description	List
PLBE2448	24" x 48"	\$266
PLBE2460	24" x 60"	\$288
PLBE2472	24" x 72"	\$313
PLBE3060	30" x 60"	\$327
PLBE3072	30" x 72"	\$360

**PLT723624L/R only available in White, Aspen, Modern Walnut, Newport Gray & Silver Birch



Shown: PLTECAB6078E3S3MLWF, PLT3072, PLT2442, RCPSBF, 33SGLUAUCCGBLK List \$2613



Shown: PLTEAB4872E3S2MWF24(2), PLT2472(2), PL143(2), PL114(2), PL144OH(2), PL44LD(2), GBM1769(2) List \$6968

For detailed product information and options, please contact your sales representative.

HEIGHT ADJUSTABLE TABLE



PL248 Pedestal Available Summer 2025

Programmable Remote with USB charger



A
Shown:
PLTEAB4872E3S2MWF24,
PLT2472
List \$1327



B
Shown:
PLTECAB6078E3S3MLWF,
PLT3072, PLT3048
List \$2170

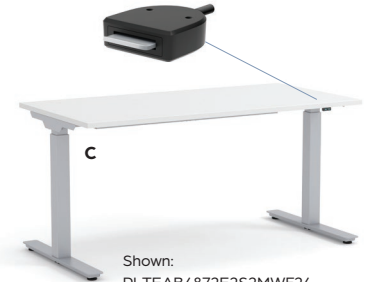

C
Shown:
PLTEAB4872E2S2MWF24,
PLT2472
List \$1127

Electrical Height Table Bases

A. Deluxe Electric Height Adjustable Table Base

Features 3 stage legs, 2 motors.
Height range with top 25.5" to 51".
Accommodates 48" wide to 72" wide tops.
Weight rating 265 lbs.
Features anti-collision protection and programmable memory handset. Adjustable glides.
Stocked in Black, Silver and White.
PLTEAB4872E3S2MWF24 - for use with 24" or 30" depth tops
List \$1075

B. Deluxe Electric Height Adjustable Corner Table Base

Features 3 stage legs, 3 motors.
Height range with top 25.5" to 51".
Accommodates 60" wide to 78" wide tops.
Weight rating 330 lbs.
Features anti-collision protection and programmable memory handset. Adjustable glides.
Stocked in Black, Silver and White.
PLTECAB6078E3S3MLWF - for use with 24" or 30" depth tops
List \$1600

C. Standard Electric Height Adjustable Table Base

Features 2 stage legs, 2 motors.
Height range with top 28" to 45".
Accommodates 48" wide to 72" wide tops.
Weight rating 175 lbs.
Features anti-collision protection and basic up/down handset. Adjustable glides.
Stocked in Black and Silver.
PLTEAB4872E2S2MWF24 - for use with 24" or 30" depth tops
List \$875



HEIGHT ADJUSTABLE TABLE



Workstation Shown: PLTEAB4872E3S2MWF24, PLT3072, 33DBLUAUCCGBLK List \$1622

THE HUMAN BODY is designed for standing, not sitting. That’s why sitting for prolonged periods of time can cause many problems. Muscle strain, neck and back stiffness, and lack of circulation can result in loss of productivity. Performance Electrical Height Adjustable Tables can help promote a healthier and more efficient workplace.



PLT723624L/R (Shown as R)

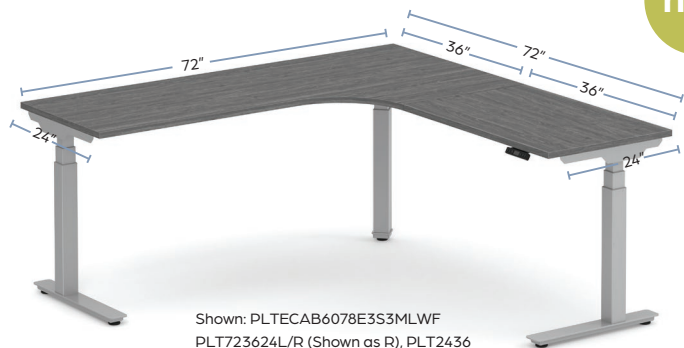

new

Shown: PLTECAB6078E3S3MLWF
PLT723624L/R (Shown as R), PLT2436
List \$2205

PORK CHOP TOPS combine style and functionality with a unique twist! These innovative desks feature a distinct, ergonomic “pork chop” shape that maximizes workspace while providing comfort and accessibility. Perfect for home offices, classrooms, or collaborative spaces, they offer a blend of modern aesthetics and practicality. Designed with durable materials and customizable finishes, Pork Chop Desks make any workspace stand out while enhancing productivity.

panels

VERSATILE PANEL OPTIONS TO ENHANCE YOUR OFFICE

Effective time management often requires a delicate balance between privacy and interaction with colleagues. Our panel systems can be retrofitted to most performance laminate work stations in a manner that allows you to define your workspace the way you want.





WEBB PANELS



THE WEBB PANEL SYSTEM In today's fast-paced work environment, optimizing productivity by allowing teams to collaborate while still offering personal havens for employees is crucial. Panel systems provide the ideal solution: from team collaboration zones to individual workstations, these versatile panels create a seamless balance between privacy and interaction, ensuring employees can thrive in their designated spaces.



Webb Panel System features 2" thick panel with thin contemporary base.



Webb Panels available in 39", 53" and 67" heights.



Slotted Tracks

Work surfaces and storage components mount to slotted tracks that run the entire height of every panel.



Raceways for Network Wiring

The raceways are plastic snap-on and are approximately 5" tall — to accommodate plenty of network wiring. The electrical system is an 8 wire, 4 circuit system, with an isolated ground circuit available.



Wedge Block Connections

Webb Panels have metal to metal, industry standard, wedge block and draw rod connections. The stability meets industry standards, and is a UL recognized product.



Contemporary Bases

Webb Panels boast thin, contemporary bases.

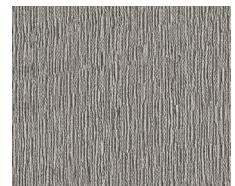

Designer Fabric

Webb Panels feature neutral gray fabric with gray/silver edge trim.

WEBB PANELS



Free standing Webb Panels shown with Elements Plus Laminate Series Height Adjustable Workstations.



6-Person Webb Panel System featuring panel supported work surfaces and storage.

Available Work Surface Finishes



Work Surfaces

Model#	Description	List
PLT2436	36" x 24"	\$174
PLT2448	48" x 24"	\$225
PLT2460	60" x 24"	\$236
PLT2472	72" x 24"	\$252
PLT3048	48" x 30"	\$243
PLT3060	60" x 30"	\$292
PLT3066	66" x 30"	\$313
PLT3072	72" x 30"	\$327
PLT3636*	36" x 36"	\$257
PLT723624L/R*	72" x 24-36"	\$431

*Only available in Aspen, Modern Walnut, White, Newport Gray & Silver Birch

Transaction Tops

Model#	Description	List
PWSTT3612	36" x 12" Transaction Top	\$118
PWSTT4812	48" x 12" Transaction Top	\$165
PWSTT7212	72" x 12" Transaction Top	\$211
PTTBKTS	Pair of Transaction Counter Brackets (2 pairs required)	\$10

Transaction tops available in Modern Walnut & White

Panel Work Surface Supports

Model#	Description	List
PWSCNTL-L	Cantilever Left	\$15
PWSCNTL-R	Cantilever Right	\$15
PWSCNTLSRD	Cantilever Left/Right Shared	\$25
PWSCNRBRKT	Corner Bracket Left/Right Pair	\$10

WEBB PANELS



Panels may be extended vertically with PL-TAP acrylic dividers for additional privacy. Available in 15" heights.



The steel overhead cabinets feature ball bearing suspensions. The flipper doors open over top of the cabinet. Lockable when closed.



Webb Panels shown with height adjustable workstations and panel supported storage.

Typical Webb Panel Configurations

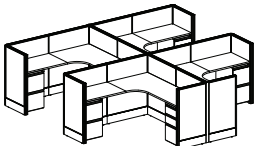

39\"/>

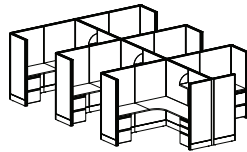

53\"/>

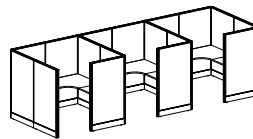

53\"/>

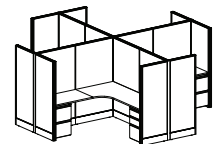

53\"/>

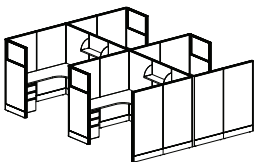

67\"/>

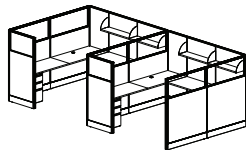

67\"/>

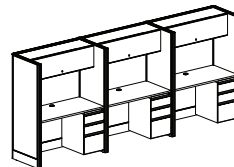

67\"/>

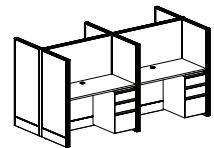

53\"/>



WEBB PANELS



Panels & Connectors 39" High

Table with 3 columns: Model#, Description, List. Lists models P3924 through PCNT39-CAP with their respective descriptions and prices.

Raceway covers sold separately

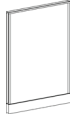

Panels & Connectors 53" High

Table with 3 columns: Model#, Description, List. Lists models P5324 through PCNT53-CAP with their respective descriptions and prices.

Raceway covers sold separately



Panel Power Modules (Required to Power Panels)

Table with 3 columns: Model#, Description, List. Lists models PPM24 24", PPM30 30", PPM36 36", and PPM48 48" with their descriptions and prices.

Raceway Covers

Table with 3 columns: Model#, Description, List. Lists models PRCW24 through PRCW48-POWER with their descriptions and prices.

Electrical & Misc

Table with 3 columns: Model#, Description, List. Lists various electrical components like jumpers, receptacles, and power poles with their descriptions and prices.



Panels & Connectors 67" High

Table with 3 columns: Model#, Description, List. Lists models P6724 through PCNT67-CAP with their respective descriptions and prices.

Raceway covers sold separately



Partial Glazed Panels & Connectors 67" High

Table with 3 columns: Model#, Description, List. Lists models PGF6724 through PCNT67-CAP with their respective descriptions and prices.

Raceway covers sold separately

Trims & Connectors

Table with 3 columns: Model#, Description, List. Lists models PCNT14CHHT through PCNTCHT234 with their descriptions and prices.

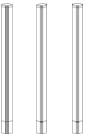

Overhead Storage

Table with 3 columns: Model#, Description, List. Lists models PFLPR30 through PSHLF48 with their descriptions and prices.

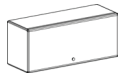

Paper Flow

Table with 3 columns: Model#, Description, List. Lists models PPFPTRY through PPFBR36/48 with their descriptions and prices.



Steel Storage

Table with 3 columns: Model#, Description, List. Lists models PPDBBF and PPDF with their descriptions and prices.



Webb panel systems are supported on 2020 Giza Designer, Cap, Kits Collaborator, and Project Matrix. Layout assistance is available.

For detailed product information and options, please contact your sales representative.

BORDERS



EFFECTIVE TIME MANAGEMENT often requires a delicate balance between privacy and interaction with colleagues. Borders can be retrofitted to most Performance laminate work stations in a manner that allows you to define your workspace the way you want. Whether you choose 24" or 36" high panels for complete privacy, 12" panels for moderate privacy or transaction tops for reception areas, Borders has a solution that will work for you and your colleagues. Contact a sales representative for further information.

FEATURES

- Modular panel system that can be retrofitted to most Performance laminate workstations
- Ideal for creating partitions between colleagues or reception station
- Available in glazed acrylic or fabric panels

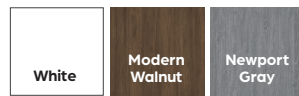
Available
Transaction
Top FinishesAvailable
Panel
MaterialAvailable
Panel Frame &
Post Finishes

Accessory Tray

Available in Silver.
Model No. PLTAT
List \$72



Pen Holder

Available in Silver.
Model No. PLTPH
List \$36



Workstation Shown: PL182L/R(4), PL192(4), PL166(4), PBP24(8), PBP12(8), PB2-SILV1236ACRYL(12) List: \$9420

BORDERS

Desk Mounted Panels



Workstation Shown: PL182L/R(4), PL192(4), PL166(4), PBP12(8), PBP24(8), PB2-BLK1236VISC311(12)
List \$9261



Workstation Shown: PL182L/R(2), PL192(2), PL166(2), PBP12(6), PBP24(5), PB2-BLK1236VISC311(9)
List \$5554



Workstation Shown: PL182L/R, PL192, PL107, PB2BLK1271ACR(2), PBP12SIL(3), PBTC71L, PBTC71R
List \$2559

Clear Acrylic Panels with Silver Frame List

PB2-SILV2024ACRCLR	24"W x 20"H w/Filler Panel	\$123
PB2-SILV2030ACRCLR	30"W x 20"H w/Filler Panel	\$150
PB2-SILV2036ACRCLR	36"W x 20"H w/Filler Panel	\$174
PB2-SILV2042ACRCLR	42"W x 20"H w/Filler Panel	\$201
PB2-SILV2048ACRCLR	48"W x 20"H w/Filler Panel	\$227
PB2-SILV2060ACRCLR	60"W x 20"H w/Filler Panel	\$278
PB2-SILV2066ACRCLR	66"W x 20"H w/Filler Panel	\$304
PB2-SILV2071ACRCLR	71"W x 20"H w/Filler Panel	\$324

Frosted Acrylic Panels with Black Frame List

PB2-BLK1224ACRYL	24"W x 12"H w/Filler Panel	\$105
PB2-BLK1230ACRYL	30"W x 12"H w/Filler Panel	\$126
PB2-BLK1236ACRYL	36"W x 12"H w/Filler Panel	\$147
PB2-BLK1242ACRYL	42"W x 12"H w/Filler Panel	\$171
PB2-BLK1248ACRYL	48"W x 12"H w/Filler Panel	\$197
PB2-BLK1260ACRYL	60"W x 12"H w/Filler Panel	\$242
PB2-BLK1266ACRYL	66"W x 12"H w/Filler Panel	\$261
PB2-BLK1271ACRYL	71"W x 12"H w/Filler Panel	\$285

Frosted Acrylic Panels with Silver Frame List

PB2-SILV1224ACRYL	24"W x 12"H w/Filler Panel	\$105
PB2-SILV1230ACRYL	30"W x 12"H w/Filler Panel	\$126
PB2-SILV1236ACRYL	36"W x 12"H w/Filler Panel	\$147
PB2-SILV1242ACRYL	42"W x 12"H w/Filler Panel	\$171
PB2-SILV1248ACRYL	48"W x 12"H w/Filler Panel	\$197
PB2-SILV1260ACRYL	60"W x 12"H w/Filler Panel	\$242
PB2-SILV1266ACRYL	66"W x 12"H w/Filler Panel	\$261
PB2-SILV1271ACRYL	71"W x 12"H w/Filler Panel	\$285

Fabric Panels with Black Frame List

PB2-BLK1224VISC311	24"W x 12"H w/Filler Panel	\$105
PB2-BLK1230VISC311	30"W x 12"H w/Filler Panel	\$126
PB2-BLK1236VISC311	36"W x 12"H w/Filler Panel	\$147
PB2-BLK1242VISC311	42"W x 12"H w/Filler Panel	\$171
PB2-BLK1248VISC311	48"W x 12"H w/Filler Panel	\$197
PB2-BLK1266VISC311	66"W x 12"H w/Filler Panel	\$261
PB2-BLK1271VISC311	71"W x 12"H w/Filler Panel	\$285

Fabric Panels with Silver Frame List

PB2-SILV1224VISC311	24"W x 12"H w/Filler Panel	\$105
PB2-SILV1230VISC311	30"W x 12"H w/Filler Panel	\$126
PB2-SILV1236VISC311	36"W x 12"H w/Filler Panel	\$147
PB2-SILV1242VISC311	42"W x 12"H w/Filler Panel	\$171
PB2-SILV1248VISC311	48"W x 12"H w/Filler Panel	\$197
PB2-SILV1266VISC311	66"W x 12"H w/Filler Panel	\$261
PB2-SILV1271VISC311	71"W x 12"H w/Filler Panel	\$285

Divider Posts

Stocked in Black and Silver		List
PBP12	Divider/Support Post 12"H	\$111
PBP24	Divider/Support Post 24"H	\$181
PBP36	Divider/Support Post 36"H	\$302

Corner Transaction Tops*

	List
PBTC36L/R 12" x 36" Specify L or R	\$142
PBTC42L/R 12" x 42" Specify L or R	\$193
PBTC66L/R 12" x 66" Specify L or R	\$216
PBTC71L/R 12" x 71" Specify L or R	\$236

*Sold individually - 2 tops needed to complete corner

Straight Transaction Tops

	List
PBTR30 12" x 30"	\$107
PBTR36 12" x 36"	\$120
PBTR48 12" x 48"	\$167
PBTR71 12" x 71"	\$197

SPACEMAX PANELS



SPACEMAX IS AN AFFORDABLE, heavy duty commercial grade panel system to be used as room dividers or in desk wrap applications. Easy to install, easy to reconfigure and a stylish contemporary design make SpaceMax a welcome addition to any office environment.

FEATURES

- 2 1/4" thick Aluminum frame construction provides outstanding strength and durability
- Installation and reconfigurations are quick and easy with SpaceMax's EZLOCK connection system
- Stylish contemporary design
- Stocked in upgraded designer fabric with Charcoal trim



Upholstered Panels

Model #	Description	List
SP6624	24"W x 66"H	\$385
SP6630	30"W x 66"H	\$421
SP6636	36"W x 66"H	\$459
SP6642	42"W x 66"H	\$501
SP6648	48"W x 66"H	\$527
SP6660	60"W x 66"H	\$609
SP6672	72"W x 66"H	\$744
SP4224	24"W x 42"H	\$340
SP4230	30"W x 42"H	\$355
SP4236	36"W x 42"H	\$378



SpaceMax's 2 1/4" Aluminum frame provides outstanding strength and durability.



Installation and reconfigurations are easy with SpaceMax's EZLOCK connection system.



Featuring a stylish contemporary trim, SpaceMax is a welcome addition to any office environment.

Glazed View-Through Panels

Model #	Description	List
SPG6624	24"W x 66"H	\$452
SPG6630	30"W x 66"H	\$487
SPG6636	36"W x 66"H	\$536

Accessories

Model #	Description	List
SP2-42	2 Way Corner Connector 42"	\$72
SP2-66	2 Way Corner Connector 66"	\$104
SP3-42	3 Way T Connector 42"	\$86
SP3-66	3 Way T Connector 66"	\$132
SP4-42	4 Way + Connector 42"	\$86
SP4-66	4 Way + Connector 66"	\$132
SPCAP-24	End Cap for Panel	\$18
SPCAP-42	End Cap for Panel	\$27
SPCAP-66	End Cap for Panel	\$38
SPPC-24	End Cap for Post	\$15
SPBASE	Support Foot (Sold Indiv.)	\$57
SPWM-42	Wall Mount Kit	\$68
SPWM-66	Wall Mount Kit	\$100



DRAWING SERVICES

Planning your furniture projects has never been easier with N9NE's complimentary drawing services. Our team provides detailed 2D top-down views, 3D line drawings, bills of materials, and professional renderings to help visualize your space and streamline the process, ensuring your project plans are just right.

To get started, contact your local dealer and provide project details, including dimensions, part numbers, and any layout specifics.

Let us help bring your vision to life!

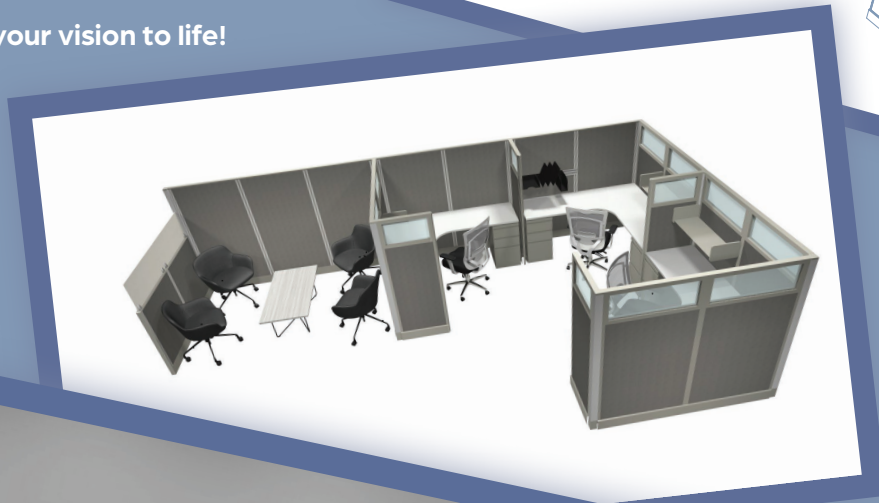
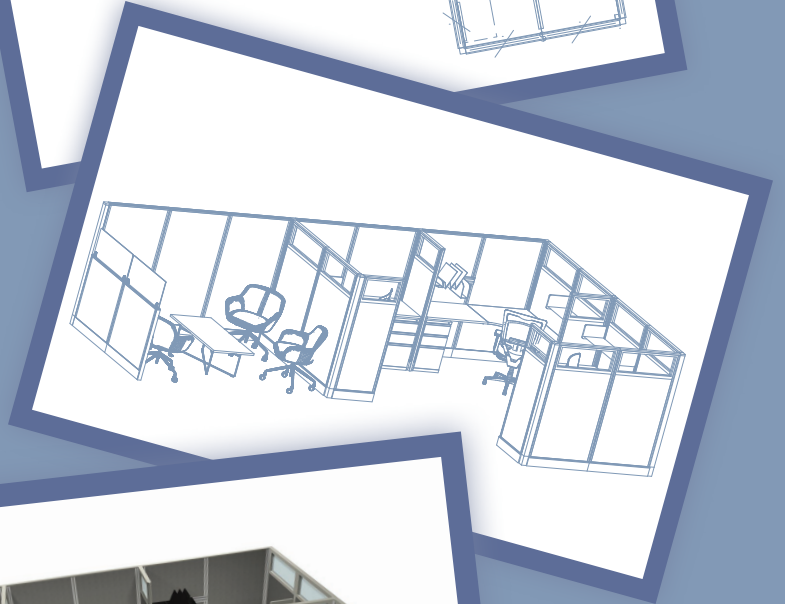
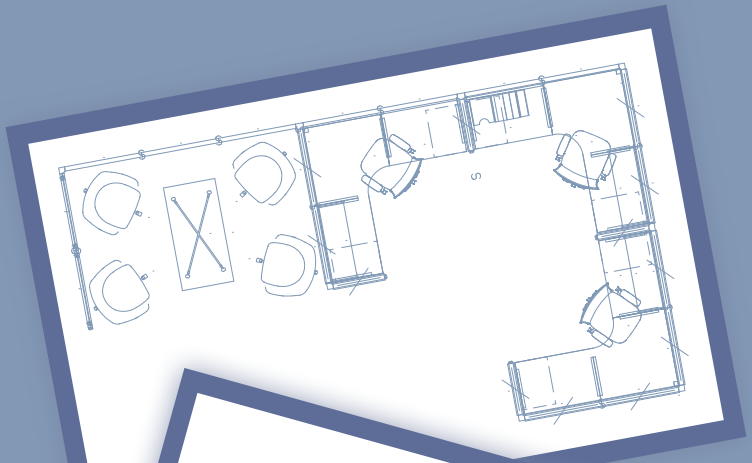

tables & presentation

TABLES THAT TRANSFORM: SOLUTIONS FOR EVERY SPACE

Our range of tables combines versatility and style to suit any environment. From economical flip top tables with convenient storage solutions to gathering and conference tables featuring durable laminate surfaces and sleek PVC Tough Edges, each option is designed for both functionality and aesthetics. For a modern touch, our clear glass-top tables with brushed steel post adapters bring contemporary elegance to both conference rooms and café settings.



Single Nesting Desk Shown: PBF60, PLT2460 List \$711





GATHERING TABLES



Single 72" Workstation Shown: PLT3072
PLTEP4130, PLTMOD4172 List \$901

ATTRACTIVE AND DURABLE laminate surfaces with PVC Tough Edge detail make these gathering tables perfect for any application. Standard 42"H.

FEATURES

- Ideal for casual meetings and collaborative spaces.
- Available in 72" and 60" widths with durable laminate surfaces for lasting use.



60" Workstation Shown: PLT3060,
PLTEP4130, PLTMOD4160
List \$866

Available Top & Base Finishes



*Maple – please call for availability.



Single 72" Workstation Shown: PLT3072, PLTEP4130, PLTMOD4172 List \$901 each

GATHERING TABLES



Gathering Work Tables: PLT3060(12), PLTLEGU60 (2), PLTLEGU4860IL (2), PLTLEGU6041H(4), PLT-MAINDESKBEAM60(15), PLTCBB(11) List \$8952

Laminate Table Tops

Model#	Description	List
PLT2448	24" x 48"	\$225
PLT2460	24" x 60"	\$236
PLT2472	24" x 72"	\$252
PLT3048	30" x 48"	\$243
PLT3060	30" x 60"	\$292
PLT3066	30" x 66"	\$313
PLT3072	30" x 72"	\$327



Single Gathering Work Table

Multi User Gathering Work Table with Inset Leg

Multi User Gathering Work Table

Tall U Leg – Silver or Black

Model#	Description	List
PLTLEGU2441H	24"W x 41"H	\$201
PLTLEGU3041H	30"W x 41"H	\$216
PLTLEGU4841H	48"W x 41"H	\$333
PLTLEGU6041H	60"W x 41"H	\$369
PLTLEGU4860IL41	Benching Inset Leg 41"H	\$591

Table Top Beam Supports

Model#	Description	List
PLT-MAINDESKBEAM48	For 48" Desktop	\$77
PLT-MAINDESKBEAM60	For 60" Desktop	\$84
PLT-MAINDESKBEAM66	For 66" Desktop	\$97
PLT-MAINDESKBEAM72	For 72" Desktop	\$104

Connector Beam Brackets (pair)

Model#	Description	List
PLTCBB	Required for each table top beam support (Silver or Black)	\$90

CUBE BASES with functional storage.

Square Laminate Table with Tall Cubed Base

Model #	Description	List
CUBB1139N	48"W x 48"D x 42"H	\$834

Available in Aspen, Espresso, Modern Walnut, Newport Gray, Cherry, Silver Birch & White in matching or contrast combinations.



Workstation Shown: CUBB1139N(3) List \$2502

FLEXTABLES



LOOKING FOR AN AFFORDABLE solution to meet your boardroom, training, and seminar needs? Flextables offer a cost-effective, modular system of tables that can be easily maneuvered to accommodate all your meeting room requirements. With contemporary laminates and durable PVC Tough Edge detailing, these tables combine flexibility, durability, and style for the workplace. Available in a variety of laminate finishes and leg options.

FEATURES

- PVC Tough Edge on all exposed edges
- T-Leg or Post Leg
- Modular and linkable
- Expandable

Available Finishes



*Maple – please call for availability.



Flextables Component Guide

Rectangular Tops

Model #	Description	List
PLT2436	24"D x 36"W	\$174
PLT2442	24"D x 42"W	\$201
PLT2448	24"D x 48"W	\$225
PLT2460	24"D x 60"W	\$236
PLT2472	24"D x 72"W	\$252
PLT3048	30"D x 48"W	\$243
PLT3060	30"D x 60"W	\$292
PLT3066	30"D x 66"W	\$313
PLT3072	30"D x 72"W	\$327
PLT3672	36"D x 72"W	\$392

Support Rails

For use with 60", 66", & 72" tops
 PLT60MS \$46 PLT72MS \$57

Ganging Hardware

PLTGC 1pk \$31

Caster Set

PLTCS \$14
 (1 locking/1 standard for PLT-TLEG24 & 30)



T-Legs

PLTTLEG24 Black only
 T-Leg For 24"D Tables \$188
 PLTTLEG30 Black only
 T-Leg For 30"D Tables \$207

Square Post Legs

PLTSQPOSTLEGAIR
 Square Post Leg (Pair)
 Black or Silver \$161

Round Post Legs

PLTPOSTLEGAIR
 Post Leg (Pair)
 Black or Silver \$161

PRESENTATION GLASS BOARDS



MAGNETIC GLASS DRY ERASE BOARDS with mounting hardware are a great solution for your office and conferencing needs.

- A. GBM1769WHITE Includes Pen Rail 17" x 69" List \$275
- B. GBM3648WHITE Includes Pen Rail 36" x 48" List \$306
- C. GBM2436WHITE Includes Pen Rail 24" x 36" List \$238



Mobile Laminated White Board

- MWB3366SI 33"W x 66"H List \$1331
- MWBGHSI 66"W x 66"H Ganging Hardware List \$36





FLIP TOP NESTING TABLES



IDEAL FOR CLASSROOM, MEETING and institutional applications, these economical flip top tables provide flexibility and convenience at an outstanding price. Featuring a quick response lever and locking casters these tables are designed so they may be nested together for easy storage. Tops are available in a variety of finishes and the bases come in black or silver. Not recommended for use with 30" deep tops.



Laminate Tops

Model#	Description	List
PLT2448	24" x 48"	\$225
PLT2460	24" x 60"	\$236
PLT2472	24" x 72"	\$252

Bevel-Edge Laminate Tops

Model#	Description	List
PLBE2448	24" x 48"	\$266
PLBE2460	24" x 60"	\$288
PLBE2472	24" x 72"	\$313

Bevel-Edge Laminate Top



White

Bases with Modesty Panels

Model #	Description	List
PBF48	for use with 48" top	\$425
PBF60	for use with 60" top	\$475
PBF72	for use with 72" top	\$500

Available Finishes



*Maple – please call for availability.

Available Base Finishes Ganging Hardware

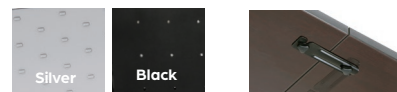

PLTGC \$31
Cannot be used with Bevel-Edge Tops

FLIP TOP NESTING TABLES



IDEAL FOR CLASSROOM, MEETING and institutional applications, these heavy duty flip top tables provide flexibility and convenience at an outstanding price. Featuring a quick response lever and locking casters these tables are designed so they may be nested together for easy storage.

Single Nesting Desk Shown: PLT3060, PTLF-60, PTLFMOD-60 List \$1011



PLT3060, PTLF-60 List \$922



PLT3072, PTLF-72, PTLFMOD-72 List \$1076

Laminate Tops

Model#	Description	List
PLT2448	24" x 48"	\$225
PLT2460	24" x 60"	\$236
PLT2472	24" x 72"	\$252
PLT3048	30" x 48"	\$243
PLT3060	30" x 60"	\$292
PLT3072	30" x 72"	\$327

Bevel-Edge Laminate Tops

Model#	Description	List
PLBE2448	24" x 48"	\$266
PLBE2460	24" x 60"	\$288
PLBE2472	24" x 72"	\$313
PLBE3060	30" x 60"	\$327
PLBE3072	30" x 72"	\$360

Bevel-Edge Laminate Top



White

Bases

Model #	Description	List
PTLF-48	for use with 48" top	\$605
PTLF-60	for use with 60" top	\$630
PTLF-72	for use with 72" top	\$650

Modesty Panels

Model #	Description	List
PTLFMOD-48	for 48" base	\$81
PTLFMOD-60	for 60" base	\$89
PTLFMOD-72	for 72" base	\$99

Available Finishes



*Maple – please call for availability.

Available Base Finishes

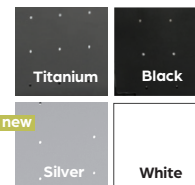

Ganging Hardware



PLTGC \$31
Cannot be used with Bevel-Edge Tops

For detailed product information and options, please contact your sales representative.



PALMER HOUSE CONFERENCE TABLES



1.5" Thick Top & PVC DuraEdge

ATTRACTIVE AND DURABLE laminate surfaces with PVC Tough Edge detail make these conference tables perfect for any application. All tables come with standard grommet.



8' Palmer House Conference Table PALBS4236N List \$2070

Boat Shaped Laminate Conference Tables with Palmer House Bases

Model #	Description	List
PALBS4236N	95"W x 33-44"D	\$2070
PALBS4237N	120"W x 33-48"D	\$3090
PALBS4238N	144"W x 33-48"D	\$3420
PALBS4168N	168"W x 33-48"D	\$4199
PALBS4192N	192"W x 33-48"D	\$4528
PALBS4216N	216"W x 33-48"D	\$5308
PALBS4240N	240"W x 33-48"D	\$5639

Available Base Finishes



Available Laminate Finishes



12' Palmer House Conference Table PALBS4238N List \$3420

CUBE BASE LAMINATE CONFERENCE TABLES



ATTRACTIVE AND DURABLE laminate surfaces with PVC Tough Edge detail make these conference tables perfect for any application. Standard 29.5"H.

Available Finishes



Racetrack Laminate Conference Tables with Cube Bases

Model #	Description	List
CUBRT3136	95"W x 44"D	\$1,035
CUBRT3137	120"W x 48"D	\$1,395
CUBRT3138	144"W x 48"D	\$1,845
CUBRT3168	168"W x 48"D	\$2,040
CUBRT3192	192"W x 48"D	\$2,500
CUBRT3216	216"W x 48"D	\$2,685
CUBRT3240	240"W x 48"D	\$3,140



12' Racetrack Conference Table with Cube Base
CUBRT3138 List \$1845



10' Boat Shaped Conference Table with Cube Base
CUBBS4237N List \$1550

Square Laminate Conference Table with Cube Base

Model #	Description	List
CUBSQ2139N	48"W x 48"D	\$724

Boat Shaped Laminate Conference Tables with Cube Bases

Model #	Description	List
CUBBS4236N	95"W x 33-44"D	\$1154
CUBBS4237N	120"W x 33-48"D	\$1550
CUBBS4238N	144"W x 33-48"D	\$2051
CUBBS4168N	168"W x 33-48"D	\$2267
CUBBS4192N	192"W x 33-48"D	\$2774
CUBBS4216N	216"W x 33-48"D	\$2990
CUBBS4240N	240"W x 33-48"D	\$3490



8' Square Conference Table with Cube Base
CUBSQ2139N(2) List \$1448



4' Square Conference Table with Cube Base
CUBSQ2139N List \$724



LAMINATE CONFERENCE TABLES



1 1/2"
Thick Top
& PVC
DuraEdge

ATTRACTIVE AND DURABLE laminate surfaces with PVC Tough Edge detail make these conference tables perfect for any application. All tables come with standard grommet.

Available Racetrack Finishes



*Maple – please call for availability.

Available Boat Shaped Finishes

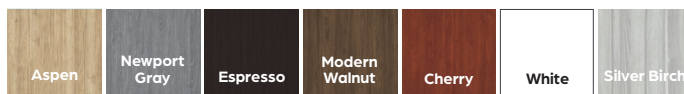

FEATURES

- Customizable tops, shapes, and legs.
- Durable laminate with PVC Tough Edge. Built-in grommets for cable management.
- Long-lasting, sleek design.with sleek design. Construction with laminate finish
- Enduring quality and beauty



8' Boat Shape Conference Table with Silver Accent Bases and Power Module CLPBS4236N, PLTBPOWER 95"W x 33-44"D List \$2040



12' Boat Shape Conference Table CLABS4238N 144"W x 33-48"D List \$1856

For detailed product information and options, please contact your sales representative.

LAMINATE CONFERENCE TABLES



10' Racetrack Conference Table CLART3137N, PLTBPOWER (2) 120"W x 48"D List \$2612



8' Racetrack Conference Table with Silver Accent Bases and Power Module: CLPRT3136N, PLTBPOWER 95"W x 44"D List \$1915



14' Racetrack Conference Table: CLART3168N 168"W x 48"D List \$2066

Racetrack Laminate Conference Tables

Model #	Description	List
CLART3135N	71"W x 35"D	\$608
CLART3136N	95"W x 44"D	\$905
CLART3137N	120"W x 48"D	\$1272
CLART3138N	144"W x 48"D	\$1704
CLART3168N	168"W x 48"D	\$2066
CLART3192N	192"W x 48"D	\$2344
CLART3216N	216"W x 48"D	\$2704
CLART3240N	240"W x 48"D	\$2990

Available in Aspen, Cherry, Espresso, Newport Gray, and Modern Walnut, and Maple*

*Maple – please call for availability.

Racetrack Laminate Conference Tables with Accent Bases

Model #	Description	List
CLPRT3136N	95"W x 44"D	\$1245
CLPRT3137N	120"W x 48"D	\$1613
CLPRT3138N	144"W x 48"D	\$2218

Available in Espresso, Newport Gray & Modern Walnut with Silver Accent Base. Available in Aspen with Black Accent Base.

Boat Shaped Laminate Conference Tables

Model #	Description	List
CLABS4235N	72"W x 36"D	\$675
CLABS4236N	95"W x 33-44"D	\$1035
CLABS4237N	120"W x 33-48"D	\$1411
CLABS4238N	144"W x 33-48"D	\$1856
CLABS4168N	168"W x 33-48"D	\$2211
CLABS4192N	192"W x 33-48"D	\$2496
CLABS4216N	216"W x 33-48"D	\$2843
CLABS4240N	240"W x 33-48"D	\$3135

Available in Aspen, Cherry, Espresso, Modern Walnut, White, Newport Gray & Silver Birch.

Boat Shaped Laminate Conference Tables with Accent Bases

Model #	Description	List
CLPBS4236N	95"W x 33-48"D	\$1370
CLPBS4237N	120"W x 33-48"D	\$1773
CLPBS4238N	144"W x 33-48"D	\$2441

Available in Espresso, Newport Gray & Modern Walnut with Silver Accent Base. Available in Aspen with Black Accent Base.

Power Module



Features 2 USB charging ports, 1 USB 3.0 data port, 1 HDMI 2.0 port, 1 RJ45 cat 6 data port, 1 RJ11 phone port and 2 power outlets. Available in Silver or Black. PLTBPOWER List \$670

Conference Power Hub



Features 5 power outlets and 4 USB charging ports. 8' power cord with surge protector. Stocked in White. Model No. PPD5E4U List \$365



SIGNATURE COLLECTION CONFERENCE TABLES



FEATURES

- Contemporary wood or metal legs for a modern, stylish aesthetic.
- Durable laminate surface with PVC Tough Edge for long-lasting use.

ATTRACTIVE AND DURABLE laminate surfaces with PVC Tough Edge detail featuring wood or metal legs, make these conference tables perfect for any application. All tables come with standard grommet.

12' Boat Shape Conference Table with Wood VA Legs and Power Modules:
SIGBS4238N-WOOD, PLTBPOWER(2)
List \$3821

Available Boat Shape Top Finishes



Boat Shape Conference Tables with Wood VA Legs			List	Boat Shape Conference Tables with Metal VA Legs			List
SIGBS4236N-WOOD	95"W x 33-44"D		\$1272	SIGBS4236N-METAL	95"W x 33-44"D		\$1215
SIGBS4237N-WOOD	120"W x 33-48"D		\$2176	SIGBS4237N-METAL	120"W x 33-48"D		\$2091
SIGBS4238N-WOOD	144"W x 33-48"D		\$2481	SIGBS4238N-METAL	144"W x 33-48"D		\$2402
SIGBS4168N-WOOD	168"W x 33-48"D		\$3148	SIGBS4168N-METAL	168"W x 33-48"D		\$3035
SIGBS4192N-WOOD	192"W x 33-48"D		\$3486	SIGBS4192N-METAL	192"W x 33-48"D		\$3372

Metal Leg Options



Black VA Leg Silver VA Leg

Wood Leg Options

with Black or Silver Mount



Modern Walnut Natural Newport Gray

Wood Leg Mount Options



Black Mount Silver Mount



8' Boat Shape Conference Table with Metal VA Legs:
SIGBS4236N-METAL List \$1215

SIGNATURE COLLECTION CONFERENCE TABLES



12' Boat Shape Conference Table with Metal VA Legs: SIGBS4238N-METAL List \$2402



14' Boat Shape Conference Table with Wood VA Legs and Power Modules: SIGBS4168N-WOOD, PLTBPOWER(3) List \$5158



ARENA CONFERENCE TABLES



Arena Conference Table with Wood VA Legs and Power Modules

ATTRACTIVE AND DURABLE laminate surfaces with PVC Tough Edge detail featuring wood or metal legs, make these conference tables perfect for any application.



10' Arena Conference Table with Metal VA Legs: SIGAR6337N-METAL List \$2145

Available Top Finish



Silver Birch

Metal Leg Options



Black VA Leg



Silver VA Leg

Wood Leg Option



Newport Gray with Black or Silver Mount

Arena Conference Tables with Metal VA Legs

		List
SIGAR6335N-METAL*	72"W x 36"D	\$885
SIGAR6336N-METAL	95"W x 48"D	\$1350
SIGAR6337N-METAL	120"W x 48"D	\$2145
SIGAR6338N-METAL	144"W x 48"D	\$2350
SIGAR6168N-METAL	168"W x 48"D	\$3095

*No Grommet

Arena Conference Tables with Wood VA Legs

		List
SIGAR6335N-WOOD*	72"W x 36"D	\$943
SIGAR6336N-WOOD	95"W x 48"D	\$1408
SIGAR6337N-WOOD	120"W x 48"D	\$2232
SIGAR6338N-WOOD	144"W x 48"D	\$2525
SIGAR6168N-WOOD	168"W x 48"D	\$3211

*No Grommet



10' Arena Conference Table with Cube Base: CUBAR6337 List \$1660

Arena Conference Tables with Cube Bases

		List
CUBSQ6339*	48"W x 48"D	\$675
CUBAR6336	95"W x 48"D	\$1300
CUBAR6337	120"W x 48"D	\$1660
CUBAR6338	144"W x 48"D	\$2150
CUBAR6168	168"W x 48"D	\$2355

*No Grommet

Available Top Finishes



Silver Birch

Available Base Finishes



White



Silver Birch

TABLES

CUSTOMIZE YOUR OFFICE WITH TABLES TAILORED FOR EVERY WORKSPACE.

Design tables that fit your unique needs, from breakrooms to collaborative spaces. Choose from a variety of top shapes and laminate colors, then select your ideal base style and height. Whether for a single table or multiple, this versatile system ensures the perfect setup for any workspace.



Tables Shown: PLTXBM24(2), PLT36R(4), PLTXBM3341(2) List \$2160



TABLE TOPS & BASES

1. CHOOSE YOUR TOP

CIRCLE, SQUARE, AND RECTANGULAR TOPS

PERFORMANCE TABLE TOPS are constructed using the highest quality thermally fused Melamine Laminates and edged with PVC Tough Edge providing unparalleled durability and beauty.



Round Tops

		List
PLT30R	30" Round Top	\$193
PLT36R	36" Round Top	\$258
PLT42R	42" Round Top	\$316

Square Bevel-Edge Tops

		List
PLBE36S	36" Square Top	\$271
Available in Newport Gray, Aspen, Silver Birch & White		
PLBE42S	42" Square Top	\$397
PLBE48S	48" Square Top	\$424
Available in White only		

Rectangular Tops

		List
PLT2436	24" x 36"	\$174
PLT2442	24" x 42"	\$201
PLT2448	24" x 48"	\$225
PLT2460	24" x 60"	\$236
PLT2472	24" x 72"	\$252
PLT3048	30" x 48"	\$243
PLT3060	30" x 60"	\$292
PLT3066	30" x 66"	\$313
PLT3072	30" x 72"	\$327

FEATURES

- Constructed with thermally fused laminate for exceptional durability.
- Available in a range of sizes and colors for complete customization.
- PVC Tough Edge provides superior impact resistance and long-lasting performance.



Round Clear Glass Tops with Post Adapter**

	List
PGT24RCLEAR 24" Round Top*	\$363
PGT36RCLEAR 36" Round Top*	\$489

*Shown with optional base, see page 81

**Only compatible with 4-Prong Brushed Metal Bases and Round Brushed Metal Bases

Available Finishes



*Maple – please call for availability.

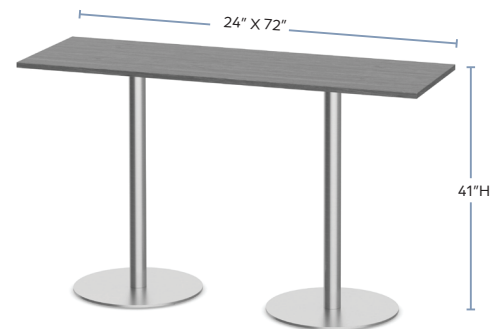

PLTRB2341BRU(2), PLT2472 List \$1330

TABLE TOPS & BASES

2. CHOOSE YOUR BASE

5 BASE STYLES TO CUSTOMIZE YOUR TABLE

PERFORMANCE TABLE BASES

are built for durability and stability, designed to withstand daily use. They are available in a range of heights – perfect for mixing high-tops and standard tables, making them ideal for break rooms or collaborative spaces.



Laminate Cross Base
PLWXB36/42 28"H Fits 36" & 42"
Round Tops
List \$128



Silver Paint Steel Base
PLTRB23SILVER – 23" Spread/28.5"H
Fits 30", 36", and 42" Round or Square Tops or as a pair for 60" & 72" wide Rectangular Tops
List \$495



A. Laminate Table w/ Metal VA Leg Base
PLT36R, PLTVAMETLEG(2), PLTVAMONOMOUNT(4)
List \$714



B. Laminate Table w/ Wood VA Leg Base
PLT36R, PLTVARWLEG(2), PLTVAMONOMOUNT(4)
List \$736

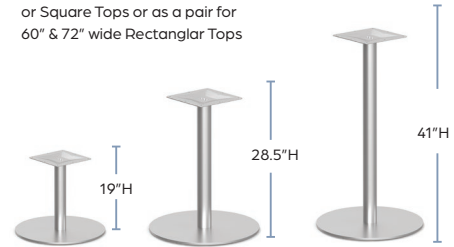

Round Brushed Metal Bases
PLTRB2319BRU 23" Base/19"H
Fits 24", 30", 36" & 42" Round Tops or 36" Square Tops
List \$479

PLTRB2328BRU 23" Base/28.5"H
Fits 24", 30", 36" & 42" Round Tops or 36" Square Tops for Cafe Style Table or as a Pair for 60" and 72" Wide Rectangular Tops
List \$495

PLTRB2341BRU 23" Base/41"H
Fits 24", 30", & 36" Round Tops or 36" Square Tops for Cafe Style Table or as a Pair for 60" and 72" Wide Rectangular Tops
List \$539

Metal VA Leg Base
PLTVAMETLEG 28"H Fits 36" & 42"
Set of 2 (Silver or Black)
List \$128

Wood VA Leg Base
PLTVARWLEG 28"H Fits 36" & 42"
Set of 2
List \$139

Single Leg Mount
PLTVAMONOMOUNT (Silver)
List \$50/each

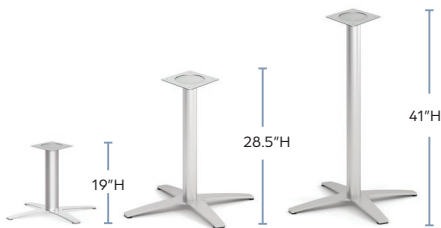

4-Prong Brushed Metal Bases
23" Spread for use with 24" round top
PLTXB2319BRU 19" H \$479
PLTXB2328BRU 28.5" H \$495
PLTXB2341BRU 41" H \$539

30" Spread for use with 36" round top
PLTXB3019BRU 19" H \$554
PLTXB3028BRU 28.5" H \$570
PLTXB3041BRU 41" H \$614



Metal Cross Bases
PLTXBM24BLK 24" Spread/28.5"H
Fits 30" & 36" Round & Square Tops
List \$258

PLTXBM33BLK 33" Spread/28.5"H
Fits 42" Round Tops
List \$270

PLTXBM3341BLK 33" Spread/41"H
Fits 30" & 36" Round Tops or 36" Square Tops for Cafe Style Table
List \$306

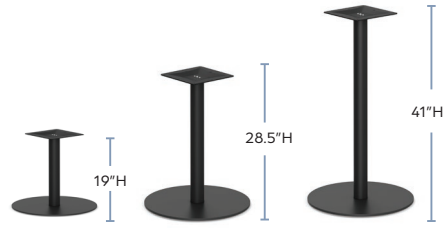

Round Black Metal Bases
PLTRB2319BLK 23" Base/19"H
Fits 24", 30", 36" & 42" Round Tops or 36" Square Tops
List \$479

PLTRB2328BLK 23" Base/28.5"H
Fits 24", 30", 36" & 42" Round Tops or 36" Square Tops for Cafe Style Table or as a Pair for 60" and 72" Wide Rectangular Tops
List \$495

PLTRB2341BLK 23" Base/41"H
Fits 24", 30", & 36" Round Tops or 36" Square Tops for Cafe Style Table or as a Pair for 60" and 72" Wide Rectangular Tops
List \$539



COFFEE + OCCASIONAL TABLES

BRING SOPHISTICATION AND FUNCTIONALITY to your office with our versatile coffee and occasional tables. Perfect for reception areas, collaborative spaces, or executive offices, these tables seamlessly blend stylish design with everyday practicality. Customize your tables to suit your space with a wide range of laminate colors and base styles, including modern cubes, round pedestals, sleek sled bases, or timeless wood designs. With options to complement any workspace, these tables provide the ideal surface for meetings, décor, or a welcoming cup of coffee. Elevate your office with furniture that balances form, function and style.



Rod Base Coffee Tables



Round Laminate Coffee Table with Black Steel Rod Base
 Model No. PLT30R/PLTWMBASE3030BLK
 30"D x 16"H. Laminate Top with Black Metal Base.
 List \$356



Rectangular Laminate Coffee Table with Black Steel Rod Base
 Model No. PLT2448/PLTWMBASE2448BLK
 24"D x 48"W x 16"H. Laminate Top with Black Metal Base.
 List \$464

COFFEE + OCCASIONAL TABLES

Cube Laminate Coffee Tables



Cube Laminate Coffee Table with Laminate Base
 Model No. PL9997/PL9999
 30"W x 30"D x 15"H.
 List \$369



Cube Laminate Coffee Table with Silver Base
 Model No. PL9997/9998
 30"W x 30"D x 18.5"H.
 List \$579



Cube Laminate Coffee Table with Angled Wood Legs
 Model No. PL9997/PLTAWRLEG
 30"W x 30"D x 18.5"H Stocked with Natural Oak, Newport Gray & Modern Walnut legs.
 List \$415

Laminate Occasional Tables

Available in Aspen, Cherry, Espresso, Newport Gray, Modern Walnut & Silver Birch.



Laminate Top With Solid Wood Base End Table
 Model No. PL220
 24"W x 24"D x 20"H
 List \$306



Laminate Top Laptop Table
 Model No. PLTLTT66T
 22"D x 15.5"W x 25.5"H
 Laminate Top with Silver Metal Base.
 List \$311



Laminate Top With Solid Wood Base Coffee Table
 Model No. PL219
 48"W x 24"D x 16"H
 List \$431



36" Laminate Top with Brushed Round Base
 Model No. PLTRB2319, PLT36R
 36"D x 20"H
 List \$737



24" Glass Top with Brushed Round Base
 Model No. PLTRB2319BRU, PGT24RCLEAR
 24"D x 19.5"H
 List \$842



24" Glass Top with X-Base
 Model No. PLTXB2319BRU, PGT24RCLEAR
 24"D x 19.5"H
 List \$842

Available Table Top Finishes



*Maple – please call for availability.

seating

SIT IN STYLE: WHERE VERSATILITY MEETS COMFORT AND DESIGN

Discover a diverse selection of seating designed to enhance any workspace with style and comfort. From the versatile Konfurb Konnect Seating, customizable to fit any office layout, to the sleek and supportive Dolce and Empire Series, each option offers a blend of contemporary design and exceptional comfort. For ergonomic excellence, the Konfurb Propel and Sense Series provide advanced adjustability and sustainable materials, ensuring every chair meets the highest standards of support and design.





CHAIR GUIDE

Reception



CHK82331 List \$715
PAGE 90



9750 List \$1115
PAGE 92



67311 List \$1175
PAGE 93



67331 List \$2200
PAGE 93



9081 List \$ 725
PAGE 94



68211 List \$900
PAGE 96



68231 List \$1700
PAGE 96



9681 List \$1000
PAGE 94



9682 List \$1400
PAGE 94

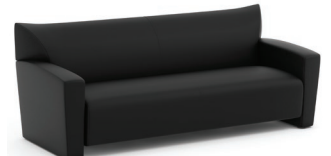

9683 List \$1800
PAGE 94



9071 List \$955
PAGE 95



9073 List \$1700
PAGE 95

Lounge



8201 List \$775
PAGE 98



7901 List \$1000
PAGE 98



6801 List \$669
PAGE 97

Management & Conference



97064 List \$1060
PAGE 99



58111 List \$740
PAGE 107



82531 List \$835
PAGE 104



69811 List \$775
PAGE 109



10911K List \$730
PAGE 108



20371S List \$687
PAGE 108



7220 List \$853
PAGE 106



67012 List \$765
PAGE 101



82611 List \$660
PAGE 106



34153 List \$725
PAGE 100



7307 List \$1068
PAGE 111



579781 List \$925
PAGE 106



70101 List \$377
PAGE 108

CHAIR GUIDE

Management & Conference



3781 List \$1079
PAGE 103



2118 List \$510
PAGE 105



82622 List \$600
PAGE 106



3702 List \$850
PAGE 102



97044 List \$485
PAGE 99



213226 List \$325
PAGE 112



58121 List \$675
PAGE 107



9802 List \$455
PAGE 112



14010 List \$449
PAGE 113



6960 List \$425
PAGE 113



9811 List \$960
PAGE 110



69011 List \$500
PAGE 111



21621 List \$530
PAGE 111

Big & Tall



8810 List \$775
PAGE 123



21010 List \$875
PAGE 123



7326 List \$1183
PAGE 122



58551 List \$950
PAGE 122



16211 List \$825
PAGE 122



8314 List \$880
PAGE 122



9910 List \$740
PAGE 123

CoolMesh Multi-Function



7704S List \$755
PAGE 116



8054S List \$691
PAGE 115



8114S List \$1011
PAGE 114



8014S List \$794
PAGE 115



7754S List \$667
PAGE 116



7701S List \$660
PAGE 117



7621A List \$497
PAGE 117

CHAIR GUIDE

Task



42551 List \$435
PAGE 120



42126 List \$431
PAGE 121



5621 List \$369
PAGE 118



6560 List \$405
PAGE 118



4464 List \$562
PAGE 119



15301 List \$360
PAGE 119



8501 List \$459
PAGE 119

Drafting Stools



6780 List \$375
PAGE 119



9805 List \$590
PAGE 125



8051 List \$690
PAGE 125



97054 List \$575
PAGE 124



7851 List \$500
PAGE 125



8501 List \$430
PAGE 125



42141GRY List \$426
PAGE 124

Guest



77560 List \$675
PAGE 126



29110 List \$499
PAGE 127



10924 List \$579
PAGE 108



36241 List \$200
PAGE 136



1700 List \$404
PAGE 127



5604 List \$349
PAGE 129



2748 List \$323
PAGE 128



2709 List \$289
PAGE 128



3703 List \$450
PAGE 128



2918T List \$344
PAGE 132



590530 List \$420
PAGE 131



590540 List \$395
PAGE 123

BIG & TALL

BIG & TALL

CHAIR GUIDE

Stacking Guest



82581 List \$240
PAGE 134



10220 List \$170
PAGE 133



3128G List \$302
PAGE 129



3129 List \$312
PAGE 129



3204TG List \$284
PAGE 134



3220TG List \$266
PAGE 134

Budget Stacking



7604TG List \$381
PAGE 132



88711 List \$300
PAGE 130



2904TG List \$333
PAGE 132



3270 List \$223
PAGE 133



3084G List \$196
PAGE 135



3080 List \$159
PAGE 135



3044 List \$130
PAGE 133

Nesting Guest



61394 List \$609
PAGE 137



8094T List \$450
PAGE 138



7794T List \$440
PAGE 138



5484 List \$417
PAGE 139



5464 List \$390
PAGE 139



3294T List \$387
PAGE 139



3274T List \$376
PAGE 139



Tempered Glass Chair Mat

Model No. GFMRC4450 List \$413
44" x 50" 1/4" tempered glass
1" radius corner



Hardwood Casters

Soft Wheel Casters for hard surfaced floors.
Available for most chairs

Model No. HARDWOODCASTER List \$36
Model No. 27/2800HARDWOODSET List \$27

Café / Bar Height



36351 List \$225
PAGE 136



3085 List \$204
PAGE 135



RECEPTION

Konfurb Konnect Reception Seating

Konnect Reception Seating seamlessly blends modern design with exceptional functionality, making it the perfect solution for stylish reception areas, hybrid work environments and collaborative spaces. With its flexible modular components and built-in connectivity features, Konnect offers the ultimate in comfort, style, and adaptability for today's dynamic workspaces. Stocked in durable, high-quality upholstery, it enhances any space with both elegance and practicality.



Center Upholstered Power Module
 Model No. 82334BGE17
 List \$130





Low Height Drop In Ottoman
Kit No. CHK82333BLKBGE17
List \$575



Corner Drop In Seat
Kit No. CHK82332BLKBGE17
List \$825



Drop In Armless Seat
Kit No. CHK82331BLKBGE17
List \$715



Drop In Square Laminate Table with Power Module
Kit No. CHK82335BLKWHT
List \$520



RECEPTION



Remix Reception Seating

Contemporary styling and a modular design makes Remix Seating the perfect fit for any office environment. Customize your layout by choosing from the components which best suit your needs. Stocked in Black Anti-Microbial Vinyl.

Anti-Microbial Vinyl



- Seat with Arms** Model No. 9750, 975ARM (2) List \$1115
- Single Seat, No Arms** Model No. 9750 - 24"W x 30"D List \$635
- Single Arm** Model No. 975ARM - 6"W. Works left or right List \$240
- 45° Corner Seat** Model No. 9755 - 31"W X 28"D List \$625
- Ottoman** Model No. 9756 - 24"W X 30"D List \$500

RECEPTION



Arlo Reception Seating

The perfect complement to the contemporary work space or home. Arlo features a wide open architecture and outstanding comfort. Heavy duty spring construction. Stocked in Light Gray Premium Bouclé fabric.



Designer Fabric Light Gray

Sofa	67331	82"W x 32.5"D x 29"H	List: \$2200
Club Chair	67311	37"W x 32.5"D x 29"H	List: \$1175

RECEPTION



Tribeca Reception Seating

Sleek European styling makes Tribeca Reception Seating the perfect choice for office or home. Featuring contemporary design, durable construction and outstanding comfort, Tribeca offers exceptional quality and value. Stocked in Black Anti-Microbial Vinyl.

Anti-Microbial Vinyl

Black

Sofa	9683 70"W x 29"D x 32"H	List: \$1800
Loveseat	9682 50"W x 29"D x 32"H	List: \$1400
Club Chair	9681 30"W x 29"D x 32"H	List: \$1000

Hyde Park Club Chair

Great looks at a budget-friendly price.



Hyde Park Club Chair
 Model No. 9081
 Stocked in Black
 Anti-Microbial Vinyl.
 List \$725



RECEPTION



Hagen Reception Seating

The perfect complement to the contemporary work space or home. Hagen features a wide open architecture, mid-century modern design and outstanding comfort. Heavy duty spring construction and deep cushioning. Stocked in Slate Designer Fabric.



Designer Fabric

Slate

Sofa	9073	73"W x 31"D x 32.5"H	List \$1700
Club Chair	9071	31"W x 31"D x 32.5"H	List \$955

RECEPTION



Enzo Reception Seating

Contemporary styling and a modern design makes Enzo Seating the perfect fit for any office environment. The sleek black legs not only provide stability but also add a touch of sophistication, complementing the overall design for a polished and inviting seating experience. Stocked in Charcoal Anti-Microbial Vinyl.



Anti-Microbial Vinyl **Charcoal**

Sofa	68231	76.5"W x 32"D x 31"H	List: \$1700
Club Chair	68211	33.5"W x 32"D x 31"H	List: \$900

LOUNGE



Konfurb Saron
 Model No. 6801/
 68SPIDMSBLACK
 4 Prong Spider Base
 with Memory Swivel
 List \$669



**Konfurb Saron
 Lounge Seating**

The Konfurb Saron Bucket Lounge Chair offers a sleek, contemporary design that combines comfort with style. Perfect for lounges, reception areas, and collaborative spaces, the Saron chair brings a modern touch to any office environment.



Konfurb Saron
 Model No. 6801/68XBASEBLACK
 X Shape Sled Base
 List \$540



Konfurb Saron
 Model No. 6801/77088NATURAL
 List \$675



Konfurb Saron
 Model No. 6801/684PRONGBLACK
 4 Prong Swivel Tilt Base
 List \$640



LOUNGE

Konfurb Neo Lounge Seating

The Konfurb Neo Lounge Seating blends modern style with functional design. Featuring a 4-prong spider base with memory swivel, the seat is upholstered in charcoal PU on the front, while the back is finished in a premium textured charcoal fabric. Perfect for lounges, reception areas, collaborative spaces, the Neo chair offers a comfortable, contemporary seating option for any office environment.



Konfurb Neo
Model No. 8201BLKMSCHAR0408
Wide Bucket Lounge Chair
with Memory Swivel
List \$775



Konfurb Magnus

The Konfurb Magnus Lounge Chair combines sleek design with robust functionality. Featuring a charcoal upholstered seat with a black metal frame, the chair is complemented by black PU on the outer back and arms for added durability and style. Perfect for contemporary office environments, lounges, and reception areas, the Magnus chair provides a modern, sophisticated seating solution.



**Konfurb Magnus Single Seater
Lounge Chair**
Model No. 7901BLKCHAR0308
List \$1000



MANAGEMENT & CONFERENCE



Konfurb AX Series

Using less to achieve more, the Konfurb AX office chair is uncomplicated in its design. It's an active seating chair, designed to improve posture by encouraging natural movement and flexibility. It's the perfect office chair for home offices or shared spaces, adjusting to everybody's unique needs.

AX Multi-Function High Back with Optional Headrest

Model No. 97064
Stocked in Gray Mesh Back with Designer Bouclé Charcoal Gray Fabric Seat and Charcoal Frame and Upgraded Casters.
List \$975

Optional Headrest
97004HR
List \$85

Advanced
4-Direction
Adjustable Arms



AX Mid Back Basic

Model No. 97044
Stocked in Gray Mesh Back with Charcoal Gray Fabric Seat and Charcoal Frame.
List \$485



AX Drafting Chair

Model No. 97054
Features metal foot ring and base. Stocked in Gray Mesh Back with Gray Fabric Seat and Charcoal Frame.
List \$575





MANAGEMENT & CONFERENCE

Konfurb Sense Series

The award-winning Konfurb Sense is an ergonomic and sustainable office chair, undercover. Manufactured from 100% recycled plastic. Its sleek lines encase a flexible, dual-sided lumbar support, while the adjustable features slip quietly into this distinctively smooth profile. The synchro mech technology gently tilts the seat and backrest in response to the body's natural movements, increasing mobility while sustaining postural support throughout the day.



Sense Executive High Back
 Model No. 34151 (Black) & 34153 (Gray)
 Stocked in Black Mesh Back with Black Fabric Seat and Black Frame. Dark Gray Mesh with Dark Gray Fabric Seat and Light Gray Frame.
 List \$725

UNIQUE DUAL LUMBAR SUPPORT
 with breathable mesh fabric back

SYNCHRONIZED MECH
 with 3° forward tilt



MANUFACTURED USING 100% RECYCLED PLASTIC

DEPTH ADJUSTABLE SEAT SLIDE
 for customizable seat depth



FEATURES

- Manufactured using 100% recycled plastic
- Tool-free assembly
- Unique dual lumbar adjustment
- Breathable mesh fabric
- High density polyurethane seat foam for durability & comfort
- Height and width adjustable arms
- Depth adjustable seat slide
- Synchronized mech with 3° forward tilt



reddot winner 2021

MANAGEMENT & CONFERENCE

Konfurb Crescent Series

The Konfurb Crescent Series combines ergonomic features with contoured design elements. Complete adjustability provides all day comfort for a multitude of uses.



Crescent Weight-Activated Syncro-Tilt High Back with Optional Headrest

Model No. 67012
 Stocked in Gray Mesh Back with Gray Fabric Seat and Light Gray Frame.
 List \$685
 Optional Headrest 67002HR
 List \$80



Advanced
 4-Direction
 Adjustable Arms

Crescent Weight-Activated Syncro-Tilt High Back with Optional Headrest

Model No. 67011
 Stocked in Black Mesh Back with Char Black Fabric Seat and Black Frame.
 List \$650
 Optional Headrest 67001HR
 List \$75

FEATURES

- Tool-free assembly
- Adjustable lumbar support
- Breathable mesh fabric
- 4D adjustable arms





MANAGEMENT & CONFERENCE

Konfurb Propel Series

Modern styling combined with optimal support make the Konfurb Propel Series a must sit. An integrated synchro control mechanism with ergonomic side-mounted controls provide effortless adjustability and comfort.

Seat Options

- Blue
- Char Black
- Gray
- Lime
- Mustard



Propel Executive High Back
 Model No. 3702
 Stocked in Cream Frame with White Mesh Back and Black Frame with Black Mesh Back and Fabric Seat in Your Choice of Color.
 List \$850



Propel Guest Chair
 See page 128



Advanced
 4-Direction
 Adjustable Arms



MANAGEMENT & CONFERENCE

Konfurb Neza

The Neza Mid-Back Chair features a unique black frame and textured 3D mesh, that blends durability with a modern, stylish design. The flexible nylon backrest adapts to your movements, while lumbar support ensures optimal comfort and promotes healthy posture throughout the day. With 4D adjustable armrests and a molded foam seat, this chair offers customizable support to suit your needs. The multifunction synchronized mechanism, complete with seat slide and four locking positions, allows for easy adjustments, making the Neza a versatile and comfortable choice for any workspace.



Optional headrest available

Konfurb Neza Headrest
Model No. 3781HRBLKF999
List \$85



Konfurb Neza
Model No. 3781BLKF999M02
List \$1079

Konfurb Neza Headrest
Model No. 3781HRBLKF999
List \$85





MANAGEMENT & CONFERENCE



Trinity Series

The Trinity is a stylish and comfortable executive chair designed to enhance modern workspaces. This chair seamlessly blends aesthetics with functionality. With the option to add a headrest, the Trinity provides extra support, making it the perfect choice for executive offices or meeting rooms where both comfort and style are essential.

Trinity Mesh Seafoam Green

Model No. 82531GRNGRN02344
Available with optional headrest
List \$760

Headrest Seafoam Green

Model No. 82531HRGRN34
List \$75



Arctic Blue



Seafoam Green



Salmon



Trinity Mesh Arctic Blue

Model No. 82531GRYWHT03343
Available with optional headrest
List \$760

Headrest Arctic Blue

Model No. 82531HRWHT343
List \$75



Trinity Mesh Salmon

Model No. 82531SALSAL04345
Available with optional headrest
List \$760

Headrest Salmon

Model No. 82531HRSAL345
List \$75



MANAGEMENT & CONFERENCE



Verde
Model No. 2118
List \$510



Verde Green
No. 2118GRNGRN4102
Green
List \$510



Verde Black
No. 2118BLKBLK0307
Black
List \$510



Verde Blue
No. 2118BLUBLU3105
Blue
List \$510



Verde Gray
No. 2118GRYGRY0604
Gray
List \$510



Verde Series

The Verde Series offers a modern, functional design with a variety of color options, providing a fresh take on executive seating. Featuring a Mesh High Back Swivel Tilter with flip and swivel arms, this chair is perfect for dynamic work environments, delivering comfort and versatility for executive offices.



MANAGEMENT & CONFERENCE

Dolce Series

The Dolce Series combines timeless sophistication with functional design, perfect for executive and meeting spaces. The collection includes High Back and Mid Back Tilter Chairs, each featuring aluminum arms and a polished chrome base. The Dolce chairs are an ideal choice for professional settings that demand both elegance and durability. **The Dolce Series will be available Spring 2025.**



Dolce Mid Back
 Model No. 82622
 Available in Black or Brown
 Anti-Microbial PU with Chrome Base
 List \$600

Dolce High Back
 Model No. 82621
 Available in Black or Brown
 Anti-Microbial PU with Chrome Base
 List \$660



Phaser Series



Phaser High Back
 Model No. 579781
 Stocked in Black Mesh with Charcoal Fabric Seat and Black Base.
 List \$925

Pivot Series



Pivot Medium Back
 Model No. 7220
 Stocked in Black Mesh with Charcoal Fabric Seat.
 List \$853



MANAGEMENT & CONFERENCE



Empire High Back
Model No. 58111CHGRY464
High Back Fabric Exec Chair
Charcoal frame (2D Arms)
List \$740



Empire Series

The Empire Series provides a refined seating solution for executive and office environments. Both chairs feature a charcoal frame with 2D adjustable arms for enhanced comfort and support. Upholstered in durable fabric, these chairs offer a sleek and professional design, making them perfect for executive offices, meeting rooms and task areas.



Empire Mid Back
Model No. 58121CHGRY464
Mid Back Fabric Exec Chair
Charcoal frame (2D Arms)
List \$675



MANAGEMENT & CONFERENCE

Nova III Series

Where European style meets function. Durable design, sleek styling, and a knee-tilt mechanism make the Nova III Series a welcome addition to any executive office or boardroom.



Nova III High Back
 Model No. 10911K
 Stocked in Black Anti-Microbial Leathertek and Light Gray Anti-Microbial Leathertek.
 List \$730



Nova III Medium Back
 Model No. 10921K
 Stocked in Black Anti-Microbial Leathertek and Light Gray Anti-Microbial Leathertek.
 List \$691



Nova III Guest Chair
 Model No. 10924
 Stocked in Black Anti-Microbial Leathertek and Light Gray Anti-Microbial Leathertek
 List \$579



Optional Arm Sleeves

Model No. 10800AC List \$26 / pair

Pentara Series



Pentara High Back
 Model No. 70101
 Stocked in Black Anti-Microbial Vinyl.
 List \$377



St James Series



St James High Back
 Model No. 20371S
 Stocked in Black Anti-Microbial Leathertek
 List \$687





MANAGEMENT & CONFERENCE

Apex Series

Where European style meets function. Uncompromising, durable design with sleek styling and syncro-tilt mechanism make the Apex Series a welcome addition to any executive office or boardroom.



Apex High Back with Adjustable Headrest
Model No. 69811
Stocked in Black and Charcoal Antimicrobial Vinyl.
List \$775



Apex Mid Back
Model No. 69821
Stocked in Black and Charcoal Antimicrobial Vinyl.
List \$700



MANAGEMENT & CONFERENCE



Atlas II
Model No. 981GRYDGRY
List \$895

new



Atlas II Optional Headrest
Model No. 981HRDGRY
List \$75

Atlas II Series

The Atlas II Series offers a sleek, customizable seating solution for modern office environments. Featuring a mesh seat and back with a charcoal frame, the armless chair can be easily upgraded with optional Loop Arms, 4D T-Arms, or a Headrest for added comfort and versatility. Ideal for task-driven spaces, the Atlas II chair combines functionality with a contemporary design to suit a variety of work settings.



Optional Loop Arms
Model No. 981LOOPGRY
List \$65



Optional Adjustable Arms
Model No. 981TARM4DGRY
List \$110

MANAGEMENT & CONFERENCE



Flint Executive High Back
Model No. 69011
Stocked in Black Mesh Back with
Black Fabric Seat and Black Frame.
List \$500



Flint Series

The Flint Executive High Back Chair combines style and comfort with a breathable black mesh back, a soft black fabric seat and a sturdy black frame. Designed for all-day comfort and support, it's perfect for any executive office or meeting space.

Nova Mesh Series



**Nova Mesh
Medium Back**
Model No. 21621
Stocked in Black Mesh and
Silver Mesh on Black Frame.
List \$530

Pilot Series



Pilot High Back with Headrest
Model No. 7307
Stocked in Black Mesh Seat and
Back with Chrome Base.
List \$1068

MANAGEMENT & CONFERENCE



new

Flora Series

Flora Gray Mid Back

Model No. 213226BGGRY0322
 Stocked in Gray Mesh with
 Gray Fabric Seat and Gray Frame.
 List \$325



Flora Black Mid Back

Model No. 213226BBBLK0108
 Stocked in Black Mesh with Black
 Fabric Seat and Black Frame.
 List \$325

Matrix Series

The Matrix Series combines style and practicality with a Plastic Back Swivel Tilter Chair and Drafting Stool. Both feature a durable black base, sleek charcoal fabric seat, and a striking geometric lattice backrest. The Chair offers a tilting mechanism for added comfort.

Matrix Drafting Stool on page. 125

new

Matrix Tilter Chair
 Model No. 9802BLKGRY201
 List \$455

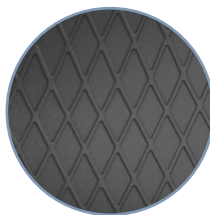

MANAGEMENT & CONFERENCE



Wren Series

Wren Swivel Tilter with Black Frame, Gray Seat
Model No. 14010BLKGRY0509
List \$449

new



Wren Swivel Tilter with Chrome Frame, Black Seat
Model No. 14010CHRBLK0508
List \$449



Wren Swivel Tilter with Chrome Frame, Gray Seat
Model No. 14010CHRGRY0509
List \$449



Stratus Series



new

Model No. 6960
Swivel Tilter w/Chrome
Arms and Base Stocked
in Black and Gray.
List \$425



COOLMESH PRO



CoolMesh Series

If your work requires you to switch between different tasks throughout the day, the CoolMesh seating series is the perfect solution. Whether you choose task seating or executive seating, CoolMesh combines an easy-flow design with multi-function adjustment capabilities and exceptional support to meet all your comfort needs.



Optional Headrest
Model No. 8000HR
List \$86



CoolMesh Pro Multi-Function High Back with Adjustable Lumbar Support and Ratchet Back Height Adjustment

Model No. 8114S
Stocked in Light Gray Mesh with White Frame and Fabric Seat in Your Choice of Color.
List \$925





COOLMESH PRO

Seat Options

Seat options for models 8114S, 8014S and 8054S. All vinyl and fabric seats come with molded foam for added comfort and longer lifespan.



Sky Blue



Gray



Lime Green



Black



Orange



Red



Cobalt Blue



Rust Orange



Smoke Gray



Olive Green



Jet Black



Antimicrobial Vinyl - Add \$27



CoolMesh Pro Multi-Function High Back with Adjustable Lumbar Support and Ratchet Back Height Adjustment

Model No. 8014S with black nylon base. Stocked in Black Mesh with Fabric Seat in Your Choice of Color. List \$794



Optional Headrest Model No. 7000HR List \$81

CoolMesh Pro Multi-Function Task with Ratchet Back Height Adjustment

Model No. 8054S with black nylon base. Stocked in Black Mesh with Fabric Seat in Your Choice of Color. List \$691



Optional Titanium Base Model No. 7700TBASE List \$130



COOLMESH

CoolMesh Series

Additional features include a breathable mesh back that promotes full-body contact, keeping you cool and supported throughout the day. The pneumatic height adjustment ensures a personalized fit, while the durable construction is designed to handle the demands of a busy work environment.



CoolMesh Multi-Function Task

Model No. 7754S with black nylon base. Stocked in Black Mesh with Fabric Seat in Your Choice of Color. List \$667



CoolMesh Multi-Function High Back

Model No. 7704S with black nylon base. Stocked in Black Mesh with Fabric Seat in Your Choice of Color. List \$755



Optional Headrest
Model No. 7000HR
List \$81



Optional Titanium Base
Model No. 7700TBASE
List \$130



COOLMESH

Seat Options

Seat options for models 8114S, 8014S and 8054S. All vinyl and fabric seats come with molded foam for added comfort and longer lifespan.



Sky Blue



Gray



Lime Green



Black



Orange



Red



Cobalt Blue



Rust Orange



Smoke Gray



Olive Green



Jet Black



Antimicrobial Vinyl - Add \$27

CoolMesh Series

CoolMesh Synchro High Back

Model No. 7701S with black nylon base. Stocked in Black Mesh with Fabric Seat in Your Choice of Color.
List \$660



Optional Headrest
Model No. 7000HR
List \$81



CoolMesh Basic Task

Model No. 7621A with black nylon base. Stocked in Black Mesh with Fabric Seat in Your Choice of Color.
List \$497



Optional Titanium Base
Model No. 7700TBASE
List \$130

TASK



Fortis Series

Fortis Swivel
Mesh Back Swivel Chair – White Frame
 Model No. 5621WHTGRY0410
 List \$369



Mimic

Mimic Black Mesh Black Seat Task Chair with Height Adjustable Arms
 Model No. 6560BLKBLK0338BLK0370
 List \$405

Mimic Gray Mesh Black Seat Task Chair with Height Adjustable Arms
 Model No. 6560BLKGRY0338BLK0370
 List \$ 405



Slip on Seat Cover Gray
 Model No. 6560SCGRY0373
 List \$21



Slip on Seat Cover Blue
 Model No. 6560SCBLU0375
 List \$21



Slip on Seat Cover Gray PU
 Model No. 6560SCGRYAM0242
 List \$21



Slip on Seat Cover Black PU
 Model No. 6560SCBLKAM0125
 List \$21



TASK

Next Series

Next Mid Back Economy Ergo Chair
 Model No. 15301
 Stocked in Back Mesh with Black Fabric Seat and Black Base.
 List \$360



Sentinel

Model No. 6780BLKM0338F0129
 Mesh back Task chair w/Flip Arms
 List \$375



ValueMesh Series

ValueMesh Basic Task
 Model No. 8501
 Stocked in Black Mesh back with Black Fabric seat.
 List \$344



Optional
 311AK Height/ width Adjustable T-Arms
 List: \$115



Stool Kit
 Model No. 100SK
 List \$86



Ergo-Form Series

Ergo-Form Multi-Function Mid Back
 Model No. 4464
 Stocked in Black Fabric.
 List \$562



Optional
 Height/width Adjustable T-Arm
 Model No. 311AK
 List: \$115



TASK

Konfurb Loop Series

The Konfurb Loop is a playfully innovative office chair designed by Martin Ballendat. Showcasing an organically contoured shell backrest that descends to fuse beneath the seat, framing the user within an artistically sculpted loop. Crafted for dynamic workspaces, it's ideal for meeting rooms, collaborative hot-desking, educational spaces and home offices.

Seat Options

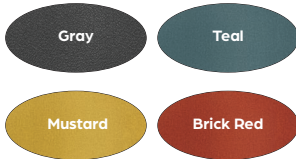

Loop White Mid Back
 Model No. 42552
 Stocked in White Back and Base with Fabric Seat in your choice of color.
 List \$510



Loop Black Mid Back
 Model No. 42551
 Stocked in Black Back and Base with Fabric Seat in your choice of color.
 List \$435





Konfurb Harmony Series

The Konfurb Harmony is an active seating office chair that is designed to improve posture by encouraging natural movement and flexibility. Designed by Martin Ballendat, the Harmony is perfect for meeting rooms, collaborative hot-desking, educational spaces and home offices.

Harmony Light Gray Mid Back

Model No. 42126GRY
Stocked in Light Gray Frame and
Polished Base with Fabric Seat in
your choice of color.
List \$431



Harmony Black Mid Back

Model No. 42121BLK
Stocked in Black Frame and
Black Base with Fabric Seat in
your choice of color.
List \$431



Seat Options

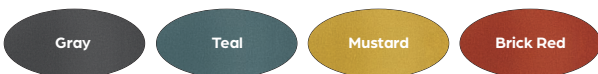

BIG & TALL

Maximus Series

Maximus Big & Tall High Back
 Model No. 58551
 Stocked in Black Mesh with Black Fabric Seat and Black Base. 450 lb weight capacity.
 List \$950



450lb
Weight
Capacity

Marco Series

Marco Big & Tall High Back
 Model No. 16211
 Stocked in Black Anti-Microbial Vinyl and Black Base. 400 lb weight capacity.
 List \$825



400lb
Weight
Capacity

Trillian Series

Trillian Tall High Back with Headrest
 Model No. 7326
 Stocked in Black Mesh with Black Fabric Seat and Chrome Base. 350 lb weight capacity.
 List \$1183



350lb
Weight
Capacity

Cool Mesh Pro XL

Cool Mesh Pro Big & Tall Chair w/Seat Slider & Arms
 Model No. 8314SPA01BLK9706
 List \$880



new
400lb
Weight
Capacity



BIG + TALL

Kingston

Big & Tall Swivel Tilter Chair
Model No. 8810BLKBLK0215
List \$775



new

400lb
Weight
Capacity

Endurance

Big & Tall Swivel Tilter Chair
Model No. 9910BLKBLK0215
List \$740



new

400lb
Weight
Capacity

Titan

Mesh Back Big & Tall Swivel Tilter Chair
with Height Adjustable Flip Arms
Model No. 21010BLKM0338F0479
List \$875



new

400lb
Weight
Capacity

Stance Series

Stance Guest Chair
Model No. 590540
Heavy Duty Big & Tall Guest chair
Available in black or gray
anti-microbial PU
List \$395



new



400lb
Weight
Capacity

**Stance Guest Chair
with Arms**
Model No. 590530
Heavy Duty Big & Tall Guest chair
Available in black or gray
anti-microbial PU
List \$420



DRAFTING

Konfurb AX Series

AX Drafting Chair

Model No. 97054

Features metal foot ring and base. Stocked in Gray Mesh Back with Gray Fabric Seat and Charcoal Frame.

List \$575



Konfurb Harmony Series

Harmony Light Gray Drafting Chair

Model No. 42141GRY

Stocked in Light Gray Frame and Black Base with Fabric Seat in your choice of color.

List \$426

Harmony Black Drafting Chair

Model No. 42141BLK

Stocked in Black Frame and Black Base with Fabric Seat in your choice of color.

List \$426

Seat Options



DRAFTING

Matrix Series

Matrix Stool

Model No. 9805BLKGRY201
List \$590

The Matrix Drafting Stool provides stable support with a non-tilt design and a handy foot ring perfect for taller workstations.



new



Spice! Series

Spice! Drafting Chair

Model No. 7851 Features metal foot ring and base. Stocked in Black. List \$500



Optional

Height/Width Adjustable
T-Arm Model No. 311AK
List \$115



CoolMesh Pro Series

CoolMesh Pro Deluxe Drafting Chair

Model No. 8051
Features metal foot ring and base.
Stocked in Black Mesh with Fabric Seat
in Your Choice of Color.
List \$575



Optional

Height/Width Adjustable
T-Arm Model No. 311AK
List: \$115

Seat Options

See page 115



Vinyl Seat
add \$27





Konfurb Hady Series

Comfortable and stylish, the Konfurb Hady is perfect for drop down seating in your home office, in waiting areas, healthcare or aged care visitor rooms. Available in three different base options to suit your home, workplace or interior fit-out.

Hady Mid Back Guest Chair with Cross Base

Model No. 77560/29091
Stocked in Gray Fabric with Black Cross Sled Base.
List \$520



Hady Mid Back Guest Chair with 4-Prong Base

Model No. 77560/29181
Stocked in Gray Fabric with 4-Prong Black Aluminum Base with Casters and Glides.
List \$630



Hady Mid Back Guest Chair with Wood Base

Model No. 77560/77088
Stocked in Gray Fabric with 4-Post Natural Finish Wood Base.
List \$675





Redmond Wood Guest Seating

Redmond Wood Chairs are constructed of solid wood for maximum strength and durability. The wood is dried to specific tolerances before milling, to ensure perfect fit of all joints and structural soundness. Joints are glued and reinforced for strength and stability.

Bonded Leather

Black

Available Chair Frame Finishes



Redmond Wood Guest Chair

Model No. 1700 Stocked in Black Bonded Leather on Modern Walnut, Cherry, Newport Gray or Espresso Frame.
List \$404

Kona Series

The perfect complement to the contemporary work space or home. Features a wide open architecture, mid-century modern design and outstanding comfort. Available in three base styles.



Kona Mid Back Guest Chair with Cross Base

Model No. 29110/29091
Stocked in Gray Fabric with Black Cross Sled Base.
List \$499



Kona Mid Back Guest Chair with 4-Prong Base

Model No. 29110/29181
Stocked in Gray Fabric with 4-Prong Black Aluminum Base with Casters and Glides.
List \$609



Kona Mid Back Guest Chair with Wood Base

Model No. 29110/77088
Stocked in Gray Fabric with 4-Post Natural Finish Wood Base.
List \$654



GUEST



Propel Series

Propel Guest Chair

Model No. 3703
 Stocked in Black Mesh Back with
 Charcoal Black Fabric Seat and
 Chrome Frame.
 List \$450



Ashton Series



**Ashton Guest Chair
 Sled Base**
 Model No. 2708
 Stocked in Black Fabric
 List \$281



Ashton Antimicrobial Vinyl Armless Guest Chair Sled Base

Model No. 2709
 Stocked in Black Antimicrobial
 Vinyl with Black Frame.
 List \$289



Ashton Antimicrobial Vinyl Guest Chair Sled Base

Model No. 2748
 Stocked in Black
 Antimicrobial Vinyl.
 List \$323

GUEST



Fortis Series

Fortis Guest
Mesh Back Guest Chair – White Frame
 Model No. 5604WHTGRY0410
 List \$349

new



Baker Series

Baker Stackable Guest Chair with Arms
 Model No. 3128G
 Stocked in Black Mesh Back with Charcoal Black Fabric Seat or Black Antimicrobial Vinyl Seat. List \$302



Optional Casters
 Model No. 27/28 List \$24



Baker Stackable Guest Chair with Arms & Casters
 Model No. 3128G with 27/28
 List \$326

Baker Stackable Guest Chair
 Model No. 3129G
 Stocked in Black Mesh Back with Charcoal Black Fabric Seat or Black Antimicrobial Vinyl Seat. List \$288



Baker Stackable Guest Chair with Casters
 Model No. 3129G with 27/28
 List \$312

GUEST



Daisy Series

The Daisy Chair offers contemporary guest seating with a modern flair, making it an ideal choice for guest, lobby and educational environments. Available in black or charcoal, the Daisy Chair provides flexibility with it's removable arms. It comes equipped with both casters and glides, allowing users to customize the chair to their specific needs.



Daisy Stackable Guest Chair with Removable Arms
 Model No. 88711
 Stocked in Black Mesh Back with Black Fabric Seat and Black Frame.
 List \$300



Daisy Stackable Guest Chair with Removable Arms
 Model No. 88714
 Stocked in Gray Mesh Back with Gray Fabric Seat and Charcoal Frame.
 List \$300



Removable Arms
Casters and Glides Included





Stance Series

The Stance Guest Chair is a robust and reliable seating option, designed to support up to 400lbs, making it perfect for any office or waiting area. Available in black or gray anti-microbial PU, it ensures both durability and cleanliness. The chair is offered with or without arms to fit a variety of needs, providing versatility and comfort for any guest.



Stance Guest Chair with Arms

Model No. 590530
Heavy Duty Big & Tall Guest chair
Available in black or gray
anti-microbial PU
List \$420



Stance Guest Chair

Model No. 590540
Heavy Duty Big & Tall Guest chair
Available in black or gray
anti-microbial PU
List \$395



STACKING GUEST

CoolMesh Series



CoolMesh Stacking Guest Chair with Casters
 Model No. 7604TG/27/28
 Stocked in Black Mesh Back with Black Fabric Seat with Titanium Frame.
 List \$405



CoolMesh Stacking Guest Chair
 Model No. 7604TG
 Stocked in Black Mesh Back with Black Fabric Seat with Titanium Frame.
 List \$381

Sleek Series



Sleek Series Sleek Stacking Chair
 Model No. 2904TG
 Stocked in Black Fabric with Titanium Frame.
 List \$333



Optional Casters
 Model No. 27/28
 List \$24



Sleek Mesh Guest Chair
 Model No. 2918T
 Stocked in Black Mesh Back with Black Fabric Seat and Titanium Frame.
 List \$344

STACKING



Reed

Stacking Guest Chair w/Arms

Model No. 10220BLKBLK0215
List \$170

new



Alpha Stacking Chair

Black CoolMesh fabric seat with matte silver sled base frame.

Alpha Stacking Chair Sled Base

Model No. 3270
Stocked in Black Fabric with Chrome-Like Powder Coated Frame.
List \$223

Alpha Chair Cart (not shown)

Model No. 3070D
Holds up to 10 chairs.
List \$130



Tec Series

Tec Stacking Guest Chair

Model No. 3044
Stocked in Black with Black Frame.
List \$130





STACKING GUEST

new

Node

The Node Stackable Guest Chairs are perfect for classrooms and multi-functional spaces. These chairs can be easily ganged together, creating seamless arrangements ideal for group settings. Additionally, they stack up to 12 chairs high, saving valuable space when not in use.



Node Stackable Guest Chair
Model No. 82581BLKF001M4201
(Stack up to 12 Chairs)
List \$240



Arc Heavy Duty Stacking Chairs

Whether you are outfitting an auditorium, dining room or classroom, Arc is the ideal solution for your stacking chair needs. All Arc stacking chairs are made with heavy duty materials and built to be both comfortable and durable. New upgraded CoolMesh fabric.



Arc Stackable Guest Chair with Arms & Casters
Model No. 3204TG/27/28
Stocked in Black with Charcoal Frame.
List \$308

Arc Stackable Guest Chair with Arms
Model No. 3204TG
Stocked in Black with Charcoal Frame.
List \$284



Arc Stackable Guest Chair with Casters
Model No. 3220TG/27/28
Stocked in Black with Charcoal Frame. List \$290



Arc Stackable Guest Chair
Model No. 3220TG
Stocked in Black with Charcoal Frame.
List \$266

BAR HEIGHT | STACKING



Agenda Plus Stacking & Bar Height

Multi-purpose stackable seating offers a versatile and economical solution for offices, meeting rooms, or dining areas. Choose from a variety of series to find the option that best suits your needs. All stacking chairs are designed with heavy-duty construction, ensuring they are both functional and comfortable.

Agenda Plus Bar Height Chair

Model No. 3085
Stocked in Black, Blue, White and Gray with Chrome Frame.
(Non-Stacking)
List \$204



Agenda Plus Stacking Chair

Model No. 3080
Stocked in Black, Blue, White and Gray with Chrome Frame.
List \$159



Agenda Plus 4 Leg Stacking Chair

Model No. 3084
Stocked in Black & Gray with Chrome Frame.
List \$177



Optional Casters
Model No. 3050CASTER
List \$19



Agenda Plus 4-Wheel Dolly
Model No. 3080D
Holds 20-25 3080 chairs.
List \$130

BAR HEIGHT | GUEST

Zest Shell Chairs

Discover lasting performance in a clearly simple package. Zest Seating combines cool, minimalist design with high performance materials to bring style and functionality to every space. Offered in a regular-height chair as well as bistro-height with low profile back.



Zest Shell Bar Height Chair
 Model No. 36351
 Bistro height - 30"H seat.
 Stocked in Blue, Gray and
 Green Fabric on Black
 Frame. List \$225

Zest Shell Chair
 Model No. 36241
 Stocked in Blue, Gray and
 Green Fabric on Black Frame.
 List \$200





NESTING GUEST

Era Series

The Era Series Nesting Flip Seat Guest Chair combines versatility and functionality. Its flip-up seat allows easy nesting and storage, while the ganging capability ensures stable, organized seating. Perfect for training rooms, conference areas, or multi-purpose spaces. The Era comes in either a black or white frame.



new



Era Nesting Guest Chair
Model No. 61394BLKF03M04
Black Frame
List \$609



Era Nesting Guest Chair
Model No. 61394WHTF03M02
White Frame
List \$609



Ganging Clip Included



Shown Ganged



Shown Nested



NESTING GUEST



CoolMesh Nesting Chairs

Maximize space without compromising style with our CoolMesh Nesting Chairs. Perfect for boardrooms and classrooms, these chairs are designed for long-lasting durability and flexibility. Choose from a range of seat colors that match the rest of the CoolMesh series, ensuring a cohesive and modern look.



CoolMesh Pro Nesting Guest Chair
Model No. 8094T
List \$450



CoolMesh Nesting Chair
Model No. 7794T
List \$440



Seat Options



NESTING GUEST

Designer Nesting Chairs

Our Nesting chairs are a great space-saving solution for boardrooms and classrooms. In addition to their contemporary look, they are built with quality materials and are made to last.

Agenda Armless Nesting Chair
Model No. 3274T
List \$376



Agenda Nesting Chair
Model No. 3294T
List \$387



Seat Options



Add \$27



Alan Series

Contemporary nesting seating with a modern flair is perfect for guest, boardrooms and educational environments. Features articulating back for added comfort. Coordinates with all Performance seating.

Alan Nesting Guest Chair with Arms
Model No. 5484
Stocked in Charcoal Gray Mesh Back with Black Fabric Seat and Black Frame. List \$417



Alan Nesting Guest Chair
Model No. 5464
Stocked in Charcoal Gray Mesh Back with Black Fabric Seat and Black Frame. List \$390



PEDESTALS

Designer Pedestals

- Includes casters and glide kit for mobile and stationary use
- All drawers on easy rolling ball-bearing suspension
- Heavy gauge steel
- Locking drawers
- Silver designer pulls
- Full suspension file drawers



Locking Mobile Box/File Pedestal with Casters
 12"W x 20"D x 20"H
 Available in White.
 Model No. RCPSBF
 List \$485



Optional Magnetic Drawer Face Cover
 Available in Mustard Yellow, Silver, Marine Blue, Paprika Orange.
 Model No. RCPSBFMAGC
 List \$75



Premium Pedestals

- All drawers on easy rolling ball-bearing suspension
- Heavy gauge steel
- Locking drawers
- Attractive full pull handles
- Double wall fronts
- Full suspension file drawers



Optional Casters
 Model No. CPPCaster
 List \$34

Locking Box/Box/File Pedestal
 15"W x 22"D x 26 1/2"H
 Available in Silver, Black & White.
 Model No. CPSBBF
 List \$535

Locking Mobile Box/File Pedestal with Casters
 15"W x 22"D x 22 1/2"H
 Available in Silver, Black & White.
 Model No. CPSBF
 List \$466



Available Finishes

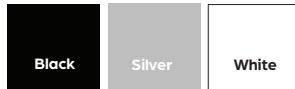

Locking File/File Pedestal
 15"W x 22"D x 26 1/2"H
 Available in Silver, Black & White.
 Model No. CPSFF
 List \$535

PEDESTALS

Compact Metal Pedestals



Free Standing Metal Pedestal with Cushion
 CMPBFSILVER/CUSH1019
 10"W x 20.25"D x 23.5"H List \$595

Optional Casters
 Model No. CPPCaster
 List \$34



Metal Pedestal for Height Adjustable Table
 Features two USB Charging Ports
 CMPBFSILVER/CMP-HBUSB
 10"W x 20.25"D List \$616

8000 Series Lateral Files

Step up to the plate with the heavy hitting Performance 8000 series lateral files. Features include heavy gauge steel construction, premium hardware and a safety feature which prevents more than one drawer opening at a time. Lock and leveling glides are standard.

- Mechanical innerlock inhibits more than one drawer from opening at a time
- Reinforced, heavy-gauge construction
- Full-width integral pulls

Available Finish



2 Drawer with Lock – 36"W
 36"W x 19 3/4"D x 27 1/2" H
 Model No. 8362
 List \$1022



3 Drawer with Lock – 36"W
 36"W x 19 3/4"D x 39 5/8" H
 Model No. 8363
 List \$1474



4 Drawer with Lock – 36"W
 36"W x 19 3/4"D x 51 1/2" H
 Model No. 8364
 List \$1801

Mobile Laminate Pedestals

The Mobile Laminate Pedestals offer flexible storage with laminate finishes that match your desk. Featuring smooth mobility, durable construction, and ample storage, they keep essentials organized while maintaining a cohesive workspace look.

Available Finishes



*Maple – please call for availability.



PL148
 2 Box / File (22" D)
 15.5" W x 28.5" H
 List \$621



PL149
 2 File (22" D)
 15.5" W x 28.5" H
 List \$621



PL1007
 Box/File (22"D)
 16"W x 22.5"H
 List \$452



Designer Fabric Cushions

Designer fabric cushions add a pop of color and practicality to your workspace. Coordinates with fabric panels and CoolMesh seating to complete the look.

Fabric Colors Available

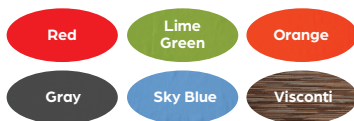

Coordinates with CoolMesh Seating

See pages 114-117



PLCUSH1522 List \$132



PLCUSH2136 List \$250
 PL1012, PL109 List \$953

CHAIR MATS

TrendSetter® Designer Chair Mats

- Transform your space with a designer chair mat
- Smooth rolling surface for ergonomic comfort
- Made in USA, Certified Woman-Owned Business

Medium Pile Carpet Chair Mat

Protects Carpet up to 3/4" (including padding). Limited Lifetime "No Crack Mat" Warranty.

Model No.	Description	List
SOESR 119732	36" x 48", Pewter, Rectangle	\$220 ea
SOESR 119742	36" x 48", Dark Cherry, Rectangle	\$220 ea
SOESR 119722	36" x 48", Driftwood, Rectangle	\$220 ea

Hard Floor Chair Mat

Protects wood, laminate, tile and other hard floor surfaces 1-Year Limited "No Crack Mat" Warranty.

Model No.	Description	List
SOESR 119762	36" x 48", Pewter, Rectangle	\$180 ea
SOESR 119772	36" x 48", Dark Cherry, Rectangle	\$180 ea
SOESR 119752	36" x 48", Driftwood, Rectangle	\$180 ea



Crafted with a durable top layer for lasting beauty

Feel Good® Anti-Fatigue Mats

ES ROBBINS Feel Good® Anti-Fatigue Mat is an ergonomic solution for workspaces that require standing for lengthy periods of time. Ideal for office, commercial, and light industrial applications.

- Raised dome surface provides fatigue relief and non-slip surface while waffle underside grips hard floor or carpet
- Tapered edges and rounded corners help eliminate trip hazard.
- 24" x 36" mat features rounded corners and molded edges.
- For dry areas only: stand up desks, cashier stations, indoor entryways, assembly stations or service counters
- Grease proof
- 2-Year Limited Warranty*
- Made in USA, Certified Woman-Owned Business

Fatigue relief and non-slip surface.

Waffle base grips floor.

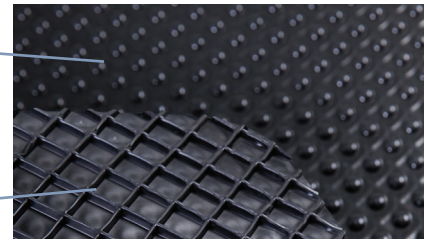

Model No.	Description	List
SOESR 184552	2' x 3' Black 3/8"	\$215 ea
SOESR 184543	3' x 5' Black 3/8"	\$345 ea
SOESR 184545	3' x 10' Black 3/8"	\$570 ea



Every Chair Needs a Chair Mat! In-Stock Plastic Chair Mats

Model No.	Description	List
122173	45" x 53" With Lip - Crystal Edge	\$172
122371	46" x 60" Rectangular - Crystal Edge	\$260
122476	48" x 72" Rectangular - Bevel Edge	\$435
122771	60" x 72" Rectangular - Bevel Edge	\$495
132121	45" x 53" Rectangular - Straight Edge	\$220

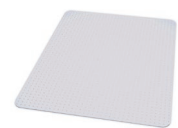

For detailed product information and options, please contact your sales representative.

CHAIR MATS

EverLife® Chair Mats

EverLife® Chair Mats protect floors while improving your mobility and comfort.

- Protect your floors from wear and tear
- Smooth rolling surface for reduced joint and muscle strain
- GREENGUARD Gold Certified
- Limited Lifetime "No Crack Mat" Warranty**
- Made in USA, Certified Woman-Owned Business



Flat to Low Pile Mat – Protects Carpet up to 1/4" Thick Including Padding

Model No.	Description	List
SOESR 120003	36" x 48" with 20" x 10" Lip, straight edge	\$125 ea
SOESR 120103	45" x 53" with 25" x 12" Lip, straight edge	\$155 ea
SOESR 120301	46" x 60", Rectangle, straight edge	\$215 ea

Low Pile Mat – Protects Carpet up to 3/8" Thick Including Padding

Model No.	Description	List
SOESR 128053	36" x 48" with 20" x 10" Lip, ramped edge	\$125 ea
SOESR 128153	45" x 53" with 25" x 12" Lip, ramped edge	\$140 ea
SOESR 128353	46" x 60" with 25" x 12" Lip, ramped edge	\$225 ea
SOESR 128351	46" x 60", Rectangle, ramped edge	\$205 ea

Medium Pile Mat – Protects Carpet up to 3/4" Thick Including Padding

Model No.	Description	List
SOESR 122153	45" x 53" with 25" x 12" Lip, ramped edge	\$172 ea
SOESR 122353	46" x 60" with 25" x 12" Lip, ramped edge	\$265 ea
SOESR 122051	36" x 48", Rectangle, ramped edge	\$200 ea
SOESR 122151	45" x 53", Rectangle, ramped edge	\$245 ea
SOESR 122351	46" x 60", Rectangle, ramped edge	\$260 ea

Hard Floor Mat For Light Use

Model No.	Description	List
SOESR 131803**	45" x 53" with 25" x 12" Lip, straight edge	\$135 ea
SOESR 131822**	46" x 60", Rectangle, straight edge	\$197 ea

**Items ESR 131803 and ESR 131822 have a one-year limited warranty



Anchorbar® Cleats

Easy to handle. Gentle on carpets and hands. No sharp spikes.



Sit or Stand Mat® For Active Workspaces

- Anti-fatigue support combined with floor protection
- Easily fold for foam cushion, then unfold for full-size chair mat
- 1-Year Limited "No Crack Mat" Warranty

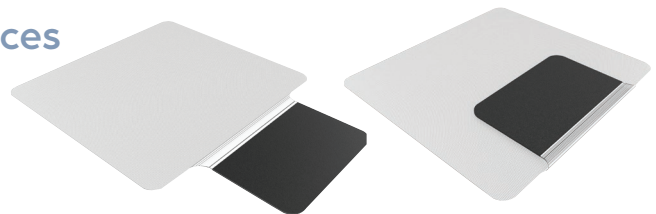

Sit or Stand Mat® For Hard Floors

Protects wood, laminate, tile and other hard floor surfaces

Model No.	Description	List
SOESR 184612	36" x 53" with 20" x 18" Lip, straight edge for hard floors	\$350 ea

Sit or Stand Mat® For Low Pile Carpet

Protects Carpet up to 3/8" (including padding). AnchorMat® cleated underside grips carpet.

Model No.	Description	List
SOESR 184619	36" x 53" with 20" x 18" Lip, straight edge for carpet	\$350 ea



THE MODERN OFFICE



MONITOR ARMS

**ELECTRIC HEIGHT
ADJUSTABLE DESK**

**DESIGNER
PEDESTAL**

**ERGONOMIC
SEATING**



MONITOR ARMS

With 360 degree rotation capability and built-in USB charging ports, our Hawk monitor arms provide unparalleled flexibility.

See page 29



ELECTRIC HEIGHT ADJUSTABLE DESK

Move from a sitting position to a standing position with the touch of a button, for enhanced productivity and comfort.

See pages 50-53



DESIGNER PEDESTALS

Whether you choose white or a pop of color, our designer pedestals combine function, convenience and style.

See page 140



ERGONOMIC SEATING

All day comfort, with award-winning design and sustainability, combine to make the new Konfurb Sense chair a smart choice.

See pages 100

STAY AHEAD WITH THE LATEST IN OFFICE FURNITURE

Throughout the year, we're constantly innovating and introducing new products to meet your needs. To ensure you always have access to our newest offerings, we've created a dedicated webpage for our latest product additions. **Simply scan the QR code below to explore these updates and keep your catalog current.** With just a quick scan, you'll unlock the most up-to-date solutions, designed to inspire and elevate your workspace all year round!

SCAN QR
FOR LATEST
PRODUCT ADDS



www.N9NEFG.com/newproducts



PL248 Available Summer 2025

Our new low-profile pedestals are designed to fit seamlessly beneath our Elements, Encore, and Signature series, as well as our height-adjustable desks. They provide the ideal combination of style and functionality.



OFFICE FURNITURE CATALOG